

2026 PRICE LIST

GREGOIR RÊVE + CAMERICH

ABOUT CAMERICH

Founded in 1997, CAMERICH is a Chinese furniture company integrating design, R&D and manufacturing. Adhering to the design philosophy of "simple yet refined", the brand dedicates itself to crafting timeless and durable furniture. Leveraging its CAMERICH (Beijing) R&D Campus and CAMERICH (Jiaxing) Mega Factory, the company continuously explores the "ordinary beauty" of furniture through design and craftsmanship, delivering high-quality products and services for users worldwide.

ABOUT GREGOIR RÊVE

Gregoir Rêve the new lifestyle business of Gregoir Group of Belgium, is the exclusive brand partner and whole distributor for CAMERICH across Benelux, France, and Germany, bringing the brand's contemporary vision of high-end furniture to these key European markets. Rooted in craftsmanship and innovation, Gregoir Rêve curates timeless, minimalist designs that elevate modern living spaces. Aligned with CAMERICH's philosophy of "Designed for Desire" and a people-first approach to design, we are committed to delivering an unparalleled luxury experience—where form meets function in perfect harmony. Explore the 2026 collection at the iconic Castle Diependael in Elewijt, Belgium.

How to Read Camerich Pricelist

1. Pricelist Organization:

The pricelist is organized by category: sofas, chairs, beds, etc. And then within each category it is alphabetized.

2. This is a sample of a product in the pricelist:

Chair
C02D0701.07

Item Code

Sketch of the item

Package Volume
VOL. 0.6m³

Price (EURO)	D	E	P+D	P+E	Q+D	Q+E	R+D	R+E	P	Q	R
	1,015	1,100	1,140	1,160	1,175	1,180	1,265	1,300	1,225	1,320	1,465

This section provides prices for fabric upholstered items. Camerich serves two grades of fabric: D and E.

This section provides prices for Leather and Fabric Combo for certain products. Typically, the leather part applies on the outer side of the product, and the fabric part applies on the inner side. Please refer to below sketch.

This section provides prices for leather upholstery items. Camerich serves four grades of leather: P,Q, and R.

P (FC): Eco-leather

Q: corrected-grain top leather

R: semi-aniline top leather

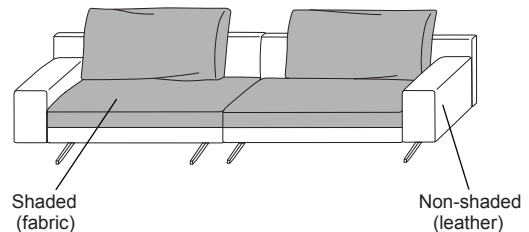
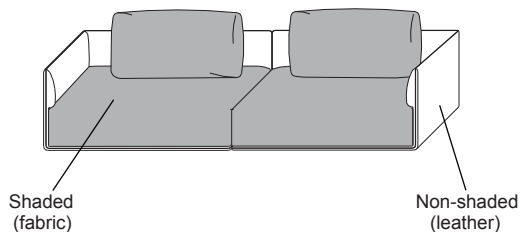
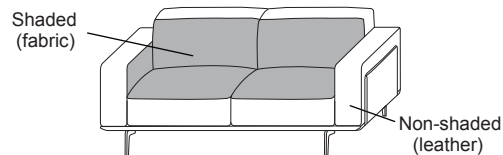
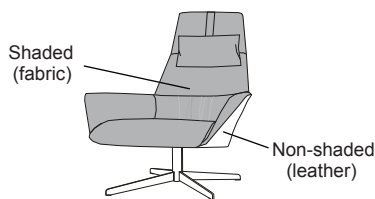

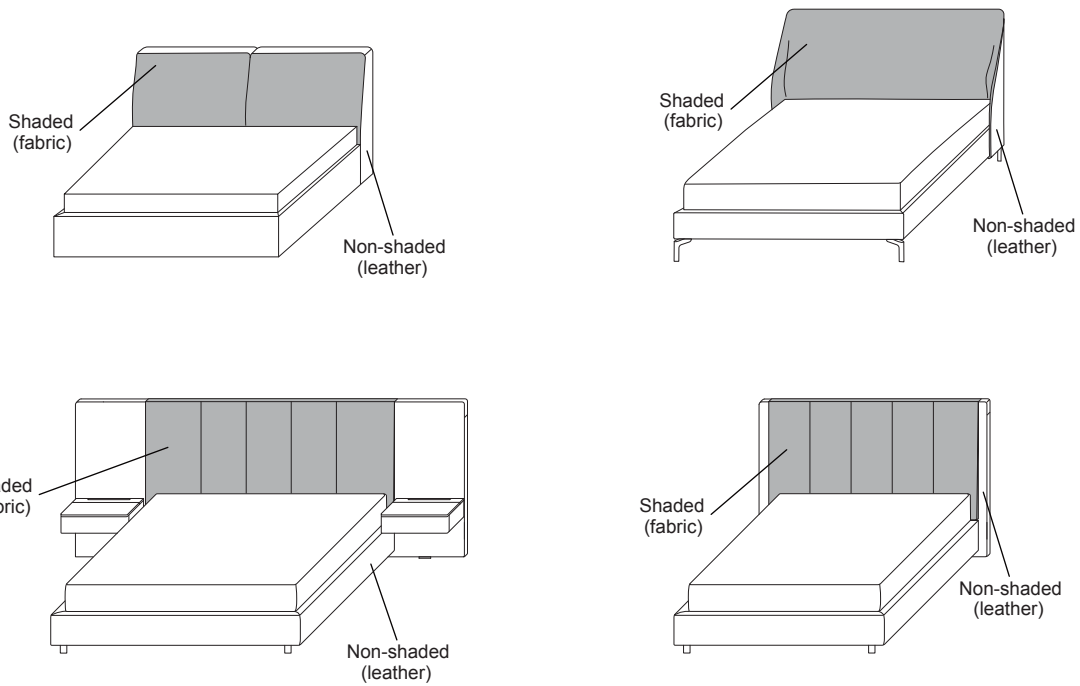

3. Additional/Replacement cover prices are provided if the cover is removable.

Armless Sofa
C01C0132.00
 Extra Cover
B10C0132.00

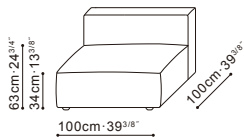

VOL. 0.75m³

	D	E	Q	R
Price (EURO)	1,190	1,275	1,365	1,650
Extra Cover (EURO)	350	435		

This section provides prices for covers.

4. Cushions or No cushions: Some of sofa products come with default cushions whereas some do not; whatever is on the sketch is what the price is inclusive of.

For example: Easytime series comes with default cushions, but Amor series do not.

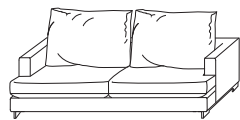

Easytime Sofa

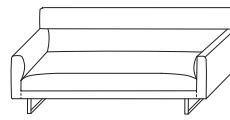

Amor sofa

Note that where cushions are not included, you need to order them individually. This provides you the flexibility of ordering as little or as many cushions as you want, and the option of ordering cushions in different fabric or leather grades.



Sofas
P19



Chairs
P093



Beds
P139



Coffee Tables
P175



Tables
P207



Cabinets
P237

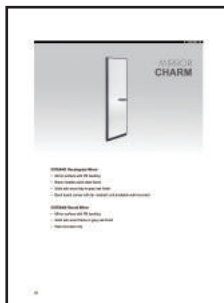

Accessories
P259



Leather Products
Stitched Seams Details
P267

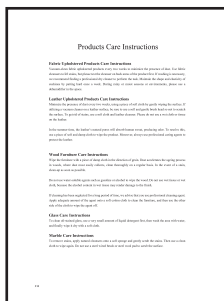

Products Care
Instructions
P282

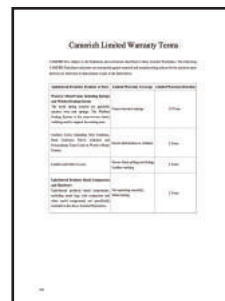

Camerich Limited
Warranty Terms
P283

Jacquard Fabric Series Suitability on Upholsteory Products

Given the properties of jacquard fabrics, only the following products in our range are applicable:

CATEGORY	SOFA	CHAIR	BED	CUSHION
FOREST	EAST-WEST-01 Inside MODA-01 Inside	AUSTEN BALLET BLEND-03 DRUM-03 ECHO LEMAN MING VENUS WING	_____	AMOR-K01 AMOR(NEW)-K01 CASA-K01 CRESCENT-K05 EPIC-K05 EAST-WEST-K05 EASYTIME-K04 ELAN-K04 ELAN(NEW)-K04 RUBIX-K04/05 REGULAR-K01 LEMAN-K01
GARDEN	CASA-13/14/15/16 MODA-03 COMBO RUBIX-35/36/37/38/39/40	BALLET BLEND-03 EMBRACE PUCK VAST VENUS	_____	AMOR(NEW)-K01 BLOOM-K04 CASA-K01 CRESCENT-K05 EASYTIME-K04 ELAN-K04 ELAN(NEW)-K04 EPIC-K05 RUBIX-K04 REGULAR-K01

Unsuitable Fabric & Leather Series on Sofa Products (I)

	CATEGORY	SOFA								
	NAME	AMOR(New)	AMOR	BLOOM	CASA	CRESCENT	EAST-WEST	EASYTIME	ELAN (New)	
	07238									
	3335									
	A1416									
	A646									
	COCO									
	DALE									
	FANCY				×		×			
	GEM									
	GERRY									
	GOYA									
FABRIC SERIES	GRACE									
	ICE CREAM	×	×	×	×	×	×		×	
	LERO									
	LINEAR									
	LUXE						×			
	MONET									
	MORGAN									
	NEMO						×			
	PANO									
	PLUSH									
	SKY									
	TRIO									
	TWILL					×				
	LEATHER SERIES	FC	×	×	×	×	×	×	×	×
		Q								
		R								
T										

Unsuitable Fabric & Leather Series on Sofa Products (II)

	CATEGORY	SOFA						
	NAME	ELAN	EPIC	MODA	NATURE	RUBIX	WAKE	LOLA
FABRIC SERIES	07238							×
	3335							×
	A1416							×
	A646							×
	COCO							×
	DALE							×
	FANCY			×		×		×
	GEM							×
	GERRY							×
	GOYA							×
	GRACE							×
	ICE CREAM	×		×	×	×	×	×
	LERO			×		×		×
	LINEAR							×(02.03,04)
	LUXE							×(02.03,06)
	MONET							×
	MORGAN							×
	NEMO							×
	PANO							×
	PLUSH					×		×
	SKY							×
	TRIO							×
TWILL			×				×	
LEATHER SERIES	FC	×	×	×	×	×	×	×
	Q							×
	R							×
	T							×

Unsuitable Fabric & Leather Series on Chair Products (I)

	CATEGORY	CHAIR							
	NAME	AUSTEN	BAIANA	BALLET	BLEND-03	DICE	DRUM-03	EASE	ECHO
FABRIC SERIES	07238		×						
	3335		×						
	A1416		×						
	A646		×						
	COCO		×						
	DALE		×						
	FANCY		×				×		
	GEM		×			×			
	GERRY		×						
	GOYA		×						
	GRACE		×						
	ICE CREAM	×	×			×	×	×	×
	LERO		×					×	
	LINEAR		×						
	LUXE		×						
	MONET		×						
	MORGAN		×						
	NEMO		×						
	PANO		×						
	PLUSH		×						
SKY		×							
TRIO		×							
TWILL		×							
LEATHER SERIES	FC	× Inside	×						
	Q								
	R								
	T								

Unsuitable Fabric & Leather Series on Chair Products (II)

	CATEGORY	CHAIR							
	NAME	EMBRACE	ESSENCE	FLORA	LEAF	LEMAN	MING	NOBLE	PUCK
FABRIC SERIES	07238		×		×				
	3335		×		×				
	A1416		×		×				
	A646		×		×				
	COCO		×		×				
	DALE		×		×			×	
	FANCY		×		×	×			
	GEM		×		×				
	GERRY		×		×				
	GOYA		×		×				
	GRACE		×		×				
	ICE CREAM	×	×	×	×	×	×	×	×
	LERO		×	×	×			×	
	LINEAR		×		×				
	LUXE		×		×				
	MONET		×		×				
	MORGAN		×		×				
	NEMO		×		×				
	PANO		×		×				
	PLUSH		×		×				
	SKY		×		×				
	TRIO		×		×				
TWILL		×		×					
LEATHER SERIES	FC		×						
	Q								
	R								
	T								

Unsuitable Fabric & Leather Series on Chair Products (III)

	CATEGORY	CHAIR						
	NAME	PUZZLE	QING	SOHO	VAST	VENUS	WALTZ PLUS	WING
FABRIC SERIES	07238	×						
	3335							×
	A1416							
	A646							
	COCO							×
	DALE						×	
	FANCY							×
	GEM							
	GERRY							
	GOYA							
	GRACE							
	ICE CREAM		×	×				×
	LERO		×					×
	LINEAR							
	LUXE							
	MONET							
	MORGAN							
	NEMO							
	PANO							
	PLUSH							
	SKY							
	TRIO							
TWILL								
LEATHER SERIES	FC							
	Q							
	R							
	T							

Unsuitable Fabric & Leather Series on Bed Products

	CATEGORY	BED								
	NAME	AMOR	EDEN	ELAN	EMBRACE	LUNA	MELODY	NATURE	STRATUS W/Drawer	STRATUS W/O Drawer
FABRIC SERIES	07238									
	3335									
	A1416									
	A646									
	COCO									
	DALE									
	FANCY								×	×
	GEM									
	GERRY									
	GOYA									
	GRACE									
	ICE CREAM	×		×	×	×	×	×	×	×
	LERO			×						
	LINEAR									
	LUXE								×	×
	MONET							×		
	MORGAN									
	NEMO									
	PANO									
	PLUSH									
	SKY									
	TRIO									
	TWILL									
LEATHER SERIES	FC	×	×	×	×	×	×	×	×	×
	Q								×	×
	R								×	
	T								×	

SOFAS

AMOR
(New)
021

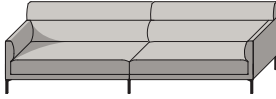

AMOR
025

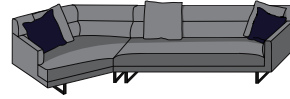

BLOOM
031



CASA
035



CLOUDS
041



CRESCENT
045



EAST-WEST
049

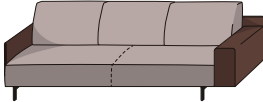

EASYTIME
053



ELAN
(New)
059



EPIC
063

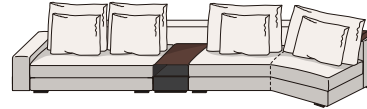

MODA
069



NATURE
073



RUBIX
077

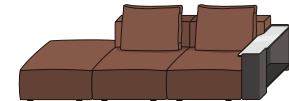

WAKE
083



SOFA BED

LOLA
091



CHAIRS

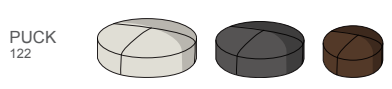
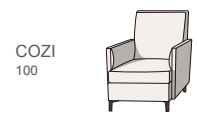
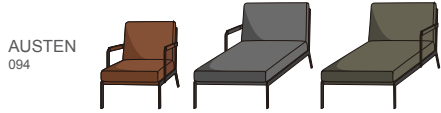

BEDS

AMOR
140

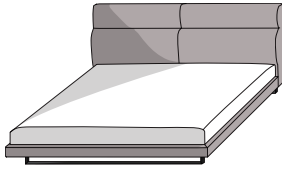

ALISON BED
PLUS
142

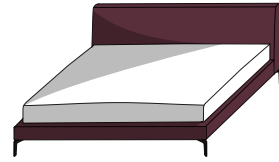

CRESCENT BED
146

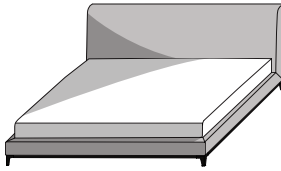

EDEN
150

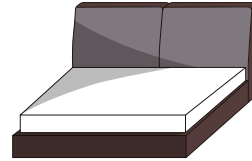

ELAN
152

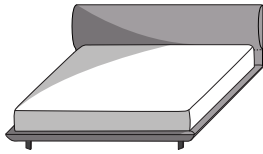

EMBRACE
156

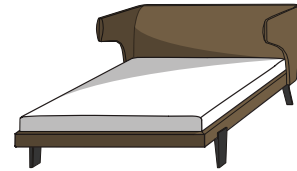

LUNA
158

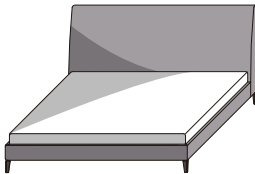

MELODY
162

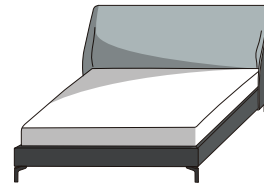

NATURE
166

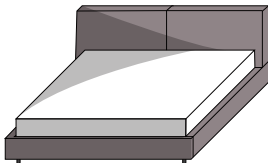

STRATUS
170

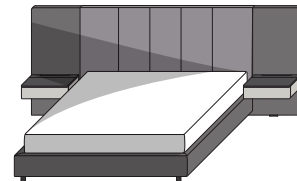

COFFEE TABLES

BLEND
176



CLEO
178



DRUM
180



ELEMENT
182



ENZO
184



FLAMINGO
186



HANNA
188



HARMON
190



JOY
192



PEBBLE
194



RUBIX
196



SLICE
198



SPIN
200



TERI
202



VARY
204

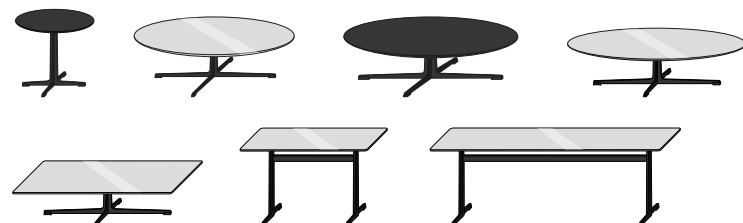

TABLES

FORMA
208



HANNA
210



JOINT
212

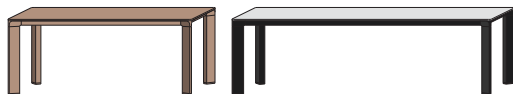

OLIVE
214



PI
216



SPIN
218

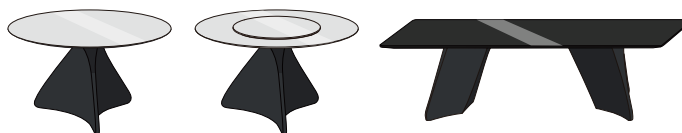

TIME
222



UNITY
224



VARY
226

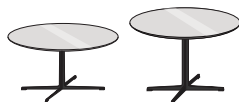

VERGE
228

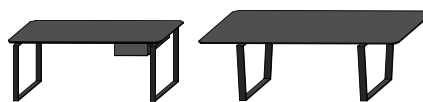

VESSEL
230



WITTY
232

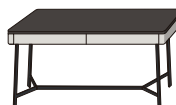

ZING
234



CABINETS

CONTENT
238

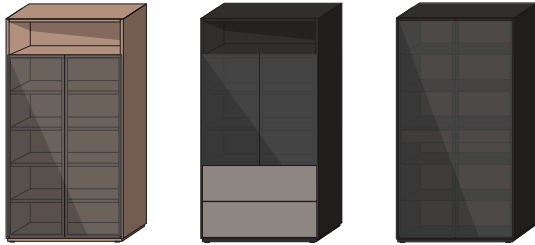

MATRIX
240



MAX
250

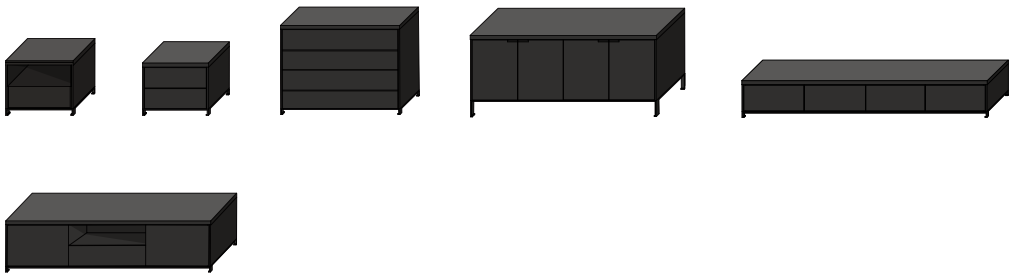

CABINETS



COAT RACK



MIRROR



SOFAS

AMOR (New)	021
AMOR	025
BLOOM	031
CASA	035
CLOUDS	041
CRESCENT	045
EAST-WEST	049
EASYTIME	053
ELAN (New)	059
EPIC	063
MODA	069
NATURE	073
RUBIX	077
WAKE	083

SOFA AMOR (New)



- An upgraded version to the AMOR collection, offering a shallower depth and more flexible combinations
- Available in Sofa, Armless Sofa, and Sectional (with curved chaise option) configurations
- Available in Fabric or Leather options. Fabric covers removable on Velcro

Construction:

Frame

- Solid birch wood frame with MDF and plywood reinforcement, seat paired with cross-woven elastic webbing
- Frame padded with modelling foam and polyurethane foam. Grey fabric lining applied over foam for fabric upholstery, leather upholstery uses a polyester fiber layer instead

Cushion

- Seat cushions filled with high-resilient variable-density polyurethane foam and polyester fiber
- Throw cushion filled with feather down and polyester fiber with hidden zipper closing

Leg

- Steel legs in grey metallic paint with plastic glides

SOFA AMOR (New)

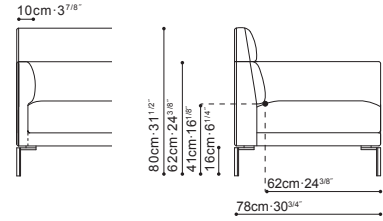

Two Seater Sofa
C01F0102.00
Extra Cover
B10F0102.00

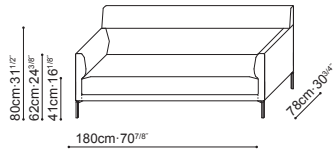

VOL. 1.1m³

Price doesn't include legs.

	D	E	Q	R
Price (EURO)	1,690	1,815	2,080	2,510
Extra Cover (EURO)	575	700		

Two Seater Sofa
C01F0103.00
Extra Cover
B10F0103.00

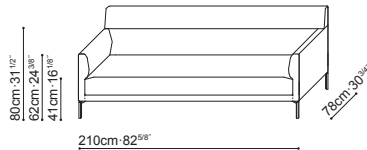

VOL. 1.25m³

Price doesn't include legs.

	D	E	Q	R
Price (EURO)	1,900	2,040	2,335	2,835
Extra Cover (EURO)	665	805		

LAF Sofa
C01F0104.00
Extra Cover
B10F0104.00

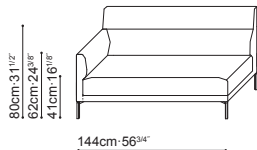

RAF Sofa
C01F0105.00
Extra Cover
B10F0105.00

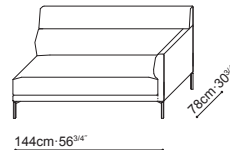

VOL. 0.9m³

Price doesn't include legs.

	D	E	Q	R
Price (EURO)	1,325	1,465	1,690	2,015
Extra Cover (EURO)	465	605		

LAF Sofa
C01F0106.00
Extra Cover
B10F0106.00

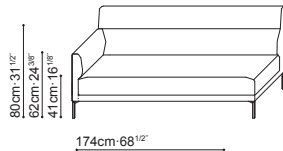

RAF Sofa
C01F0107.00
Extra Cover
B10F0107.00

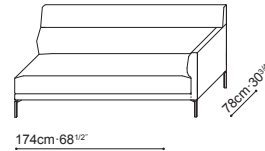

VOL. 1.0m³

Price doesn't include legs.

	D	E	Q	R
Price (EURO)	1,550	1,690	1,935	2,330
Extra Cover (EURO)	550	690		

AMOR (New)

LAF Curved Chaise
C01F0112.00
 Extra Cover
B10F0112.00

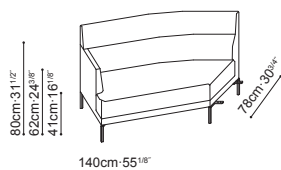

RAF Curved Chaise
C01F0113.00
 Extra Cover
B10F0113.00

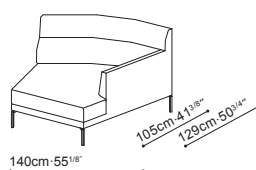

VOL. 1.15m³

Price doesn't include legs.

	D	E	Q	R
Price (EURO)	1,550	1,690	1,935	2,330
Extra Cover (EURO)	550	690		

Armless Curved Sofa
C01F0114.00
 Extra Cover
B10F0114.00

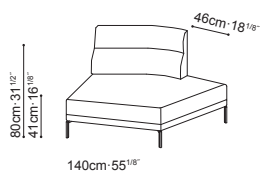

Armless Curved Sofa
C01F0115.00
 Extra Cover
B10F0115.00

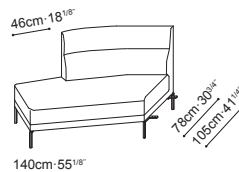

VOL. 1.05m³

Price doesn't include legs.

	D	E	Q	R
Price (EURO)	1,290	1,415	1,650	1,970
Extra Cover (EURO)	440	565		

Standard Leg 2PCS
B11F0101.34.0000



75

Standard Connector Leg 2PCS
B11F0102.34.0000

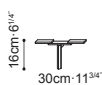

75

Cushion
C08F0101.00
 Extra Cover
B80F0101.00

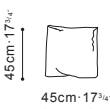

	D	E	Q	R
Price (EURO)	75	85	135	160
Extra Cover (EURO)	50	60	110	135

AMOR (New) Leg Explanation

Certain combinations of the Amor(New) Sofa will allow the utilization of a shared Connector Leg which helps keep clean silhouette whilst reduces your overall costs. This document clarifies which legs are needed for which specific Amor (New) pieces.

First, there are two types of Sofa Legs for the Amor (New):

Standard Leg 2PCS
B11F0101.34.0000



Standard Connector Leg 2PCS
B11F0102.34.0000

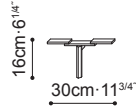

Thus, there are Two Types of Leg Boxes:

B11F0101 Standard Leg, comes qty 2 legs per box

B11F0102 Standard Connector Leg, comes qty 2 legs per box

Legs Required per Amor (New) Sofa Piece:

Description	SKU	Leg Boxes Required per Piece
Arm Sofas	C01F0102 C01F0103	2 Boxes of B11F0101
LAF/RAF Sofas	C01F0104/05 C01F0106/07	2 Boxes of B11F0101
LAF/RAF Curved Chaises	C01F0112/13	2 Boxes of B11F0101
Armless Curved Sofas	C01F0114/15	2 Boxes of B11F0101

Legs Required per Amor (New) Sectional Set-Up:

LAF/RAF Sofas / Curved Chaises	Combining w/ Chaises	Leg Boxes Required per Sectional
C01F0104/05/06/07	Curved Chaises C01F0112/13	2 Boxes of B11F0101 + 1 Box of B11F0102
C01F0104/05/06/07	Armless Curved Chaises C01F0114/15	2 Boxes of B11F0101 + 1 Box of B11F0102
C01F0112/13	Armless Curved Chaises C01F0114/15	2 Boxes of B11F0101 + 1 Box of B11F0102

SOFA AMOR



- Features unique “double folded” tight back design
- Available in Sofa and Sectional (with angled chaise option) configurations
- Available in Fabric or Leather options. Fabric covers removable on Velcro

Construction:

Frame

- Solid birch wood frame with MDF and plywood reinforcement, seat paired with cross-woven elastic webbing
- Frame padded with modelling foam and polyurethane foam. Grey fabric lining applied over foam for fabric upholstery, leather upholstery uses a polyester fiber layer instead

Cushion

- Seat cushions filled with high-resilient variable-density polyurethane foam and polyester fiber
- Throw cushions filled with feather down and polyester fiber
- All cushions have hidden zipper closing

Leg

- Steel legs in black metallic paint with plastic glides

SOFA AMOR

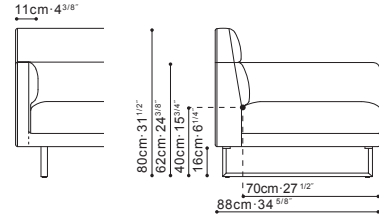

Two Seater Sofa
C01B0101.3A
Extra Cover
B10B0101.00

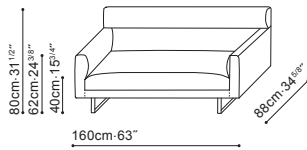

VOL. 1.0m³

	D	E	Q	R
Price (EURO)	1,900	2,125	2,445	2,950
Extra Cover (EURO)	575	800		

Two Seater Sofa
C01B0102.3A
Extra Cover
B10B0102.00

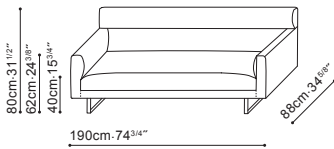

VOL. 1.2m³

	D	E	Q	R
Price (EURO)	2,125	2,350	2,730	3,265
Extra Cover (EURO)	665	890		

Two Seater Sofa
C01B0103.3A
Extra Cover
B10B0103.00

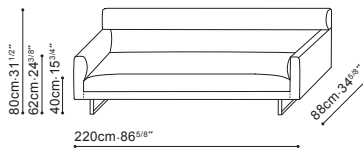

VOL. 1.4m³

	D	E	Q	R
Price (EURO)	2,350	2,575	2,980	3,555
Extra Cover (EURO)	750	975		

LAF Sofa
C01B0104.3A
Extra Cover
B10B0104.00

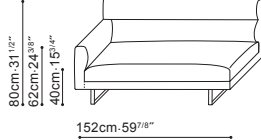

RAF Sofa
C01B0105.3A
Extra Cover
B10B0105.00

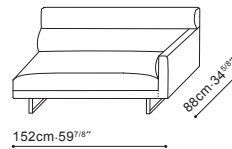

VOL. 1.0m³

	D	E	Q	R
Price (EURO)	1,775	1,990	2,225	2,655
Extra Cover (EURO)	540	755		

LAF Sofa
C01B0106.3A
 Extra Cover
B10B0106.00

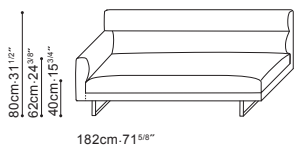

RAF Sofa
C01B0107.3A
 Extra Cover
B10B0107.00

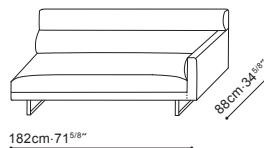

VOL. 1.15m³

	D	E	Q	R
Price (EURO)	1,990	2,215	2,515	3,015
Extra Cover (EURO)	625	850		

LAF Sofa
C01B0108.3A
 Extra Cover
B10B0108.00

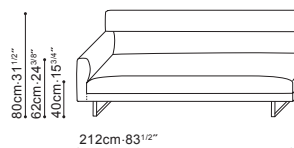

RAF Sofa
C01B0109.3A
 Extra Cover
B10B0109.00

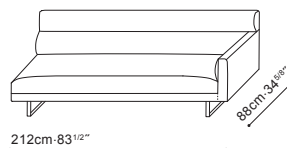

VOL. 1.35m³

	D	E	Q	R
Price (EURO)	2,215	2,440	2,760	3,300
Extra Cover (EURO)	715	940		

LAF Chaise
C01B0120.3A
 Extra Cover
B10B0120.00

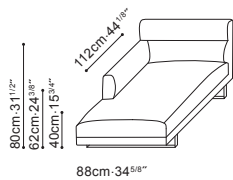

RAF Chaise
C01B0121.3A
 Extra Cover
B10B0121.00

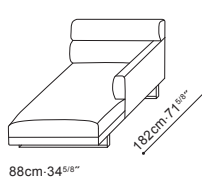

VOL. 1.15m³

	D	E	Q	R
Price (EURO)	1,950	2,175	2,480	2,985
Extra Cover (EURO)	600	825		

LAF Angled Chaise
C01B0114.3A
 Extra Cover
B10B0114.00

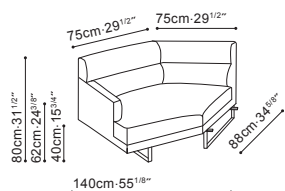

RAF Angled Chaise
C01B0115.3A
 Extra Cover
B10B0115.00



VOL. 1.15m³

	D	E	Q	R
Price (EURO)	2,090	2,300	2,550	3,050
Extra Cover (EURO)	640	850		

LAF Angled Chaise
C01B0116.3A
 Extra Cover
B10B0116.00

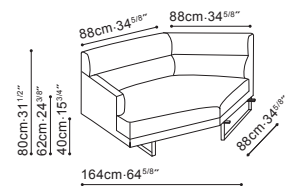

RAF Angled Chaise
C01B0117.3A
 Extra Cover
B10B0117.00

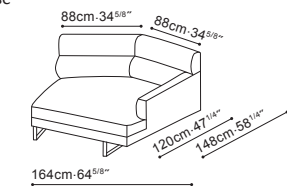

VOL. 1.4m³

	D	E	Q	R
Price (EURO)	2,300	2,525	2,805	3,345
Extra Cover (EURO)	725	950		

AMOR

Cushion

C08B0101.00

Extra Cover

B80B0101.00

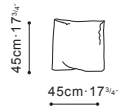

	D	E	Q	R
Price (EURO)	90	100	145	175
Extra Cover (EURO)	55	65	110	140

Regular Cushion

C08TYK01.00

Extra Cover

B80TYK01.00



	D	E	F	Q	R
Price (EURO)	75	85	90	95	120
Extra Cover (EURO)	50	60	65	70	95

AMOR Leg Explanation

Note: This document clarifies which legs are needed for which specific Amor pieces

When we reference "Amor Sofa 01" we are referring to the last two digits on the item code C01B0101

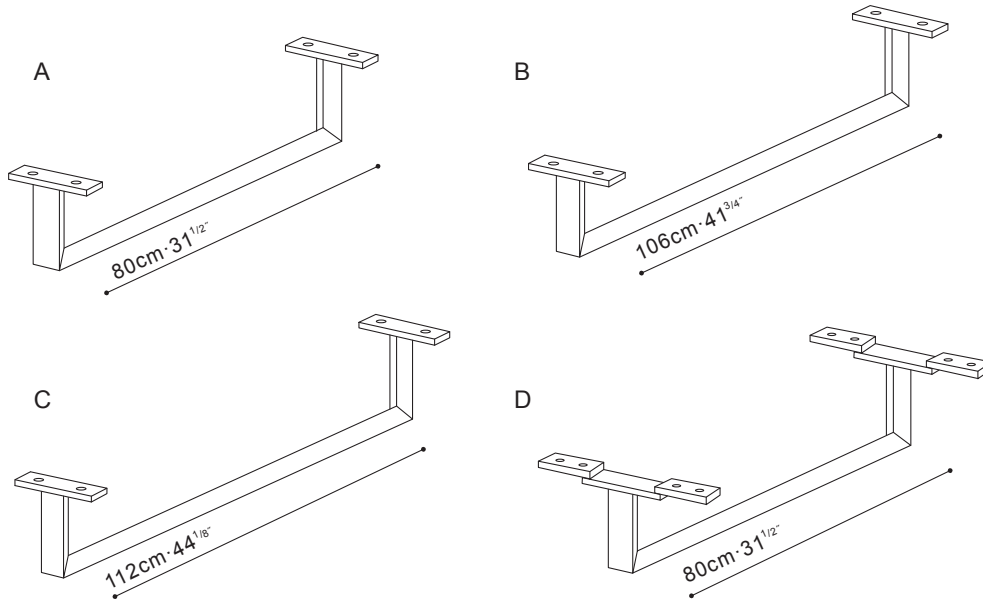

Four Types of Legs Boxes

(Leg A+A)

(Leg A+D)

(Leg B) or (Leg C) (Same box)

(Leg D)

SOFA Set Up

Items	Total Box(es) Legs Required
Amor Sofas 01, 02, 03	1 Box (Leg A+A)
Amor Sofas 04/05, 06/07, 08/09	1 Box (Leg A+A)
Amor Chaises 20/21	1 Box (Leg A+A)

SECTIONAL Set Up (Sofa + Chaise)

Sofas	Combining with Chaise	Total Box(es) Legs Required
Amor Sofas 04/05, 06/07, 08/09	Amor Standard Chaises 20/21	2 Boxes (Leg A+A)&(Leg A+A)
Amor Sofas 04/05, 06/07, 08/09	Amor Angled Chaises 14/15	2 Boxes (Leg A+D)&(Leg B)
Amor Sofas 04/05, 06/07, 08/09	Amor Angled Chaises 16/17	2 Boxes (Leg A+D)&(Leg C)

ANGLED CHAISES COMBINED Set Up (Angled Chaise + Angeled Chaise)

Sofas	Combining with Chaise	Total Box(es) Legs Required
Amor Angeled Chaise 14	Amor Angeled Chaise 15	3 Boxes (Leg B)&(Leg B)&(Leg D)
Amor Angeled Chaise 16	Amor Angeled Chaise 17	3 Boxes (Leg C)&(Leg C)&(Leg D)

SOFA BLOOM



- Modular design with Arm Sofa, Armless Sofa, Hexagon Corner Sofa, Chaise, and Ottoman to create flexible configurations
- Detachable L shape leather upholstered component is unique to the Bloom series
- Available in Fabric or Leather options. Fabric covers removable on Velcro (armrests and backrests need to be unscrewed in order for covers to be removed)

Construction:

Frame

- Steel frame for armrest and backrest, reinforced by plywood and MDF, covered with polyurethane foam, modelling foam, and polyester fiber
- Solid birch wood seat frame with plywood reinforcements, paired with cross-woven elastic webbing, sinuous and balance springs, covered with polyurethane foam and polyester fiber. Grey fabric lining applied over foam for fabric upholstery
- Sofa base comes standard with pre-set metal connectors

Cushion

- Seat and back cushions consist of channeled feather down and polyester fiber padding with high-resilient polyurethane foam center insert
- Throw cushion filled with feather down and polyester fiber
- All cushions have hidden zipper closing

Leg

- Inset black plastic (ABS) legs giving the sofa a “floating” design

SOFA BLOOM

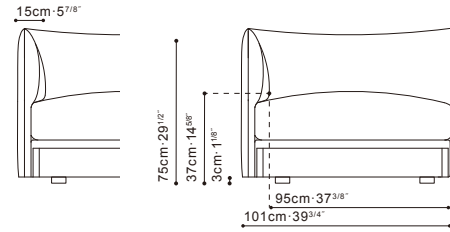

LAF L-Component Sofa
C01G0101.00
Extra Cover
B10G0101.00

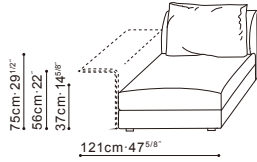

RAF L-Component Sofa
C01G0102.00
Extra Cover
B10G0102.00

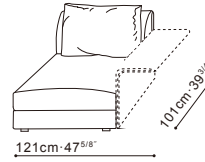

VOL. 0.9m³

Price doesn't include L- Component.

	D	E	Q	R
Price (EURO)	1,500	1,640	2,050	2,410
Extra Cover (EURO)	490	630		

Corner Sofa
C01G0103.00
Extra Cover
B10G0103.00

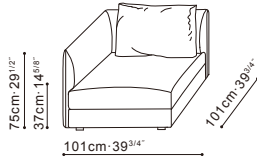

VOL. 0.95m³

Corner sofa can serve as either a LAF or RAF sofa.

	D	E	Q	R
Price (EURO)	1,815	1,975	2,520	2,950
Extra Cover (EURO)	575	735		

Armless L-Component Sofa
C01G0104.00
Extra Cover
B10G0104.00

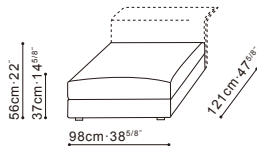

VOL. 0.5m³

Price doesn't include L- Component.

	D	E	Q	R
Price (EURO)	975	1,065	1,295	1,475
Extra Cover (EURO)	315	405		

Armless Sofa
C01G0105.00
Extra Cover
B10G0105.00



VOL. 0.9m³

	D	E	Q	R
Price (EURO)	1,500	1,640	2,050	2,410
Extra Cover (EURO)	490	630		

Ottoman
C01G0106.00
 Extra Cover
B10G0106.00

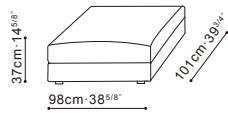

VOL. 0.55m³

	D	E	Q	R
Price (EURO)	975	1,065	1,295	1,475
Extra Cover (EURO)	315	405		

LAF L-Component Sofa
C01G0107.00
 Extra Cover
B10G0107.00

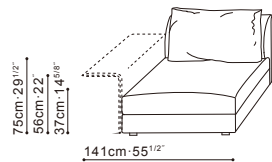

RAF L-Component Sofa
C01G0108.00
 Extra Cover
B10G0108.00

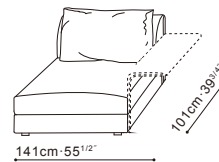

VOL. 1.1m³

Price doesn't include L- Component.

	D	E	Q	R
Price (EURO)	1,725	1,890	2,340	2,770
Extra Cover (EURO)	550	715		

LAF Sofa
C01G0109.00
 Extra Cover
B10G0109.00

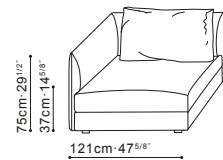

RAF Sofa
C01G0110.00
 Extra Cover
B10G0110.00

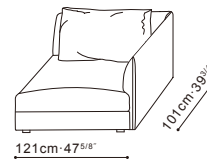

VOL. 1.15m³

	D	E	Q	R
Price (EURO)	2,040	2,215	2,800	3,300
Extra Cover (EURO)	640	815		

Armless L-Component Sofa
C01G0111.00
 Extra Cover
B10G0111.00

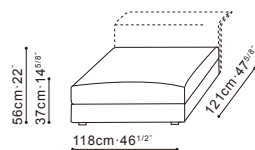

VOL. 0.6m³

	D	E	Q	R
Price (EURO)	1,065	1,150	1,405	1,620
Extra Cover (EURO)	350	435		

Armless Sofa
C01G0112.00
 Extra Cover
B10G0112.00



VOL. 1.1m³

	D	E	Q	R
Price (EURO)	1,725	1,890	2,340	2,770
Extra Cover (EURO)	550	715		

BLOOM

LAF Chaise
C01G0113.00
 Extra Cover
B10G0113.00

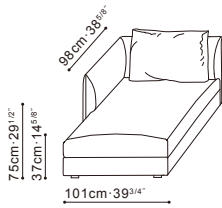

RAF Chaise
C01G0114.00
 Extra Cover
B10G0114.00

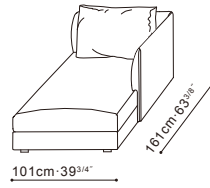

VOL. 1.5m³

	D	E	Q	R
Price (EURO)	2,175	2,350	3,020	3,525
Extra Cover (EURO)	690	865		

LAF Chaise
C01G0117.00
 Extra Cover
B10G0117.00

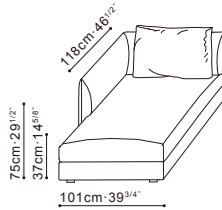

RAF Chaise
C01G0118.00
 Extra Cover
B10G0118.00

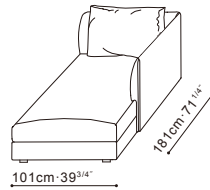

VOL. 1.7m³

	D	E	Q	R
Price (EURO)	2,390	2,590	3,295	3,870
Extra Cover (EURO)	750	950		

Hexagon Corner Sofa
C01G0121.00
 Extra Cover
B10G0121.00

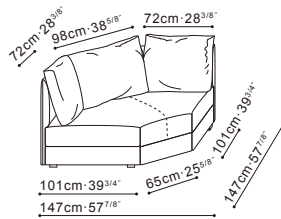

VOL. 1.8m³

	D	E	Q	R
Price (EURO)	3,365	3,640	4,130	4,850
Extra Cover (EURO)	975	1,250		

L-Component (98cm)
B12G0122.00

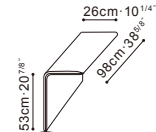

VOL. 0.2m³

	Q	R
Price (EURO)	525	625

L-Component (118cm)
B12G0123.00

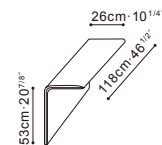

VOL. 0.25m³

	Q	R
Price (EURO)	625	725

Cushion
C08G0104.00
 Extra Cover
B80G0104.00



	D	E	Q	R
Price (EURO)	90	100	160	190
Extra Cover (EURO)	65	75	135	165

SOFA CASA



- Modular design with Arm Sofa, Armless Sofa, and Ottoman in two depths and various widths to create flexible configurations
- “L” shape Ottomans C0102013 and C0102014 are unique to the Casa collection
- Available in Fabric or Leather options. Fabric covers removable on Velcro

Construction:

Frame

- Solid birch wood and plywood frame with MDF reinforcement, paired with cross-woven elastic webbing, covered with polyurethane foam, polyester fiber and grey fabric lining
- Sofa base comes standard with pre-set metal connectors

Cushion

- Seat cushions consist of high-resilient polyurethane foam and compartmented feather down top
- Back cushions C0802002, C0802003 and C0802004 consist of channeled feather down padding with high-resilient polyurethane foam center insert
- Throw cushion C0802001 filled with feather down
- All cushions have hidden zipper closing

Leg

- Inset black plastic (ABS) legs giving the sofa a “floating” design

SOFA CASA

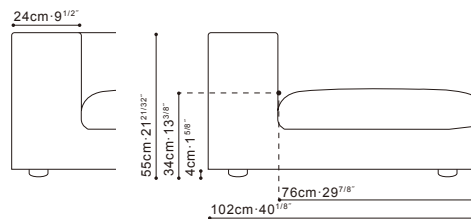

Armless Sofa
C0102025.00
Extra Cover
B1002025.00

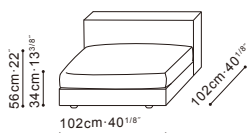

VOL. 0.7m³

	D	E	Q	R
Price (EURO)	1,065	1,240	1,370	1,620
Extra Cover (EURO)	290	465		

Armless Sofa
C0102026.00
Extra Cover
B1002026.00

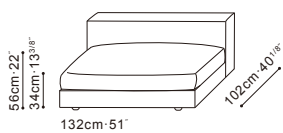

VOL. 0.85m³

	D	E	Q	R
Price (EURO)	1,240	1,375	1,615	1,935
Extra Cover (EURO)	350	485		

Armless Sofa
C0102027.00
Extra Cover
B1002027.00

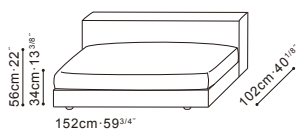

VOL. 1.0m³

	D	E	Q	R
Price (EURO)	1,325	1,465	1,755	2,115
Extra Cover (EURO)	425	565		

LAF Sofa
C0102017.00
Extra Cover
B1002017.00

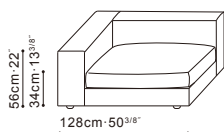

RAF Sofa
C0102018.00
Extra Cover
B1002018.00

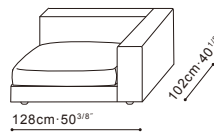

VOL. 0.85m³

	D	E	Q	R
Price (EURO)	1,290	1,415	1,650	1,970
Extra Cover (EURO)	400	525		

CASA

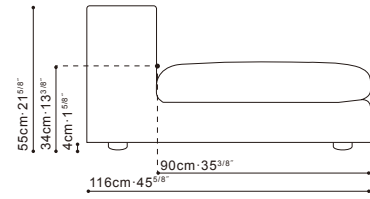

LAF Sofa
C0102019.00
 Extra Cover
B1002019.00

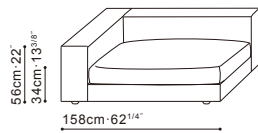

RAF Sofa
C0102020.00
 Extra Cover
B1002020.00

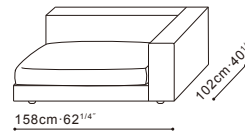

VOL. 1.05m³

	D	E	Q	R
Price (EURO)	1,415	1,600	1,870	2,230
Extra Cover (EURO)	440	625		

Armless Sofa
C0102010.00
 Extra Cover
B1002010.00

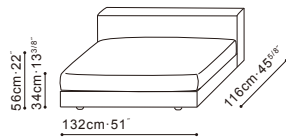

VOL. 0.95m³

	D	E	Q	R
Price (EURO)	1,325	1,465	1,755	2,115
Extra Cover (EURO)	425	565		

Armless Sofa
C0102011.00
 Extra Cover
B1002011.00

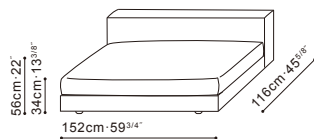

VOL. 1.1m³

	D	E	Q	R
Price (EURO)	1,465	1,640	2,015	2,410
Extra Cover (EURO)	440	615		

LAF Sofa
C0102003.00
 Extra Cover
B1002003.00

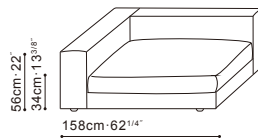

RAF Sofa
C0102004.00
 Extra Cover
B1002004.00

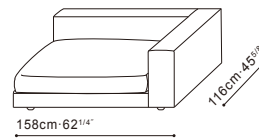

VOL. 1.15m³

	D	E	Q	R
Price (EURO)	1,640	1,775	2,080	2,475
Extra Cover (EURO)	515	650		

CASA

LAF Sofa
C0102005.00
 Extra Cover
B1002005.00

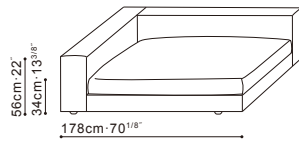

RAF Sofa
C0102006.00
 Extra Cover
B1002006.00

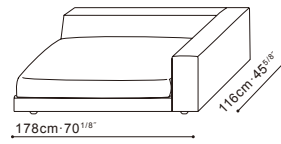

VOL. 1.3m³

	D	E	Q	R
Price (EURO)	1,725	1,900	2,440	2,905
Extra Cover (EURO)	540	715		

Ottoman
C0102013.00
 Extra Cover
B1002013.00

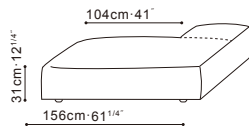

Ottoman
C0102014.00
 Extra Cover
B1002014.00

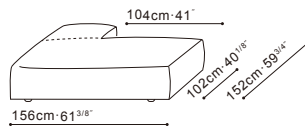

VOL. 0.8m³

	D	E	Q	R
Price (EURO)	1,040	1,175	1,325	1,575
Extra Cover (EURO)	265	400		

Ottoman
C0102015.00
 Extra Cover
B1002015.00

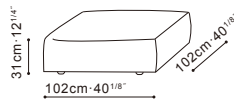

VOL. 0.5m³

	D	E	Q	R
Price (EURO)	925	1,065	1,190	1,440
Extra Cover (EURO)	225	365		

Ottoman
C0102016.00
 Extra Cover
B1002016.00

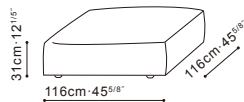

VOL. 0.6m³

	D	E	Q	R
Price (EURO)	975	1,115	1,260	1,510
Extra Cover (EURO)	240	380		

Cushion
C0802004.00
 Extra Cover
B8002004.00

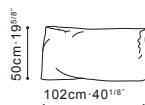

	D	E	Q	R
Price (EURO)	215	240	415	500
Extra Cover (EURO)	125	150	325	410

Cushion

C0802003.00

Extra Cover

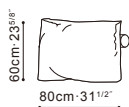
B8002003.00

	D	E	Q	R
Price (EURO)	175	215	355	440
Extra Cover (EURO)	100	140	280	365

Cushion

C0802002.00

Extra Cover

B8002002.00

	D	E	Q	R
Price (EURO)	125	140	260	325
Extra Cover (EURO)	75	90	210	270

Cushion

C0802001.00

Extra Cover

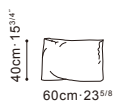
B8002001.00

	D	E	Q	R
Price (EURO)	90	100	110	130
Extra Cover (EURO)	65	75	85	105

SOFA CLOUDS



- Modular design with Arm Sofa, Armless Sofa, Chaise, and Ottoman in two depths and various widths to create flexible configurations
- Available in Fabric or Leather options. Fabric covers removable on Velcro

Construction:

Frame

- Solid birch wood frame with MDF and plywood reinforcements, paired with cross-woven elastic webbing
- Frame covered with polyurethane foam and fabric lining
- Sofa base comes standard with pre-set metal connectors

Cushion

- Seat cushions consist of high-resilient polyurethane foam, topped with compartmented feather down and polyester fiber
- Back cushions C0802201, C0802202 and C0802203 consist of channeled feather down and polyester fiber padding with high-resilient polyurethane foam center insert
- Throw cushion C0802204 filled with feather down
- All cushions have hidden zipper closing

Leg

- Steel legs in black metallic paint with plastic glides

SOFA CLOUDS

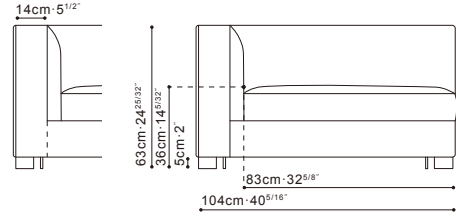

LAF Sofa
C0102201.3A
Extra Cover
B1002201.

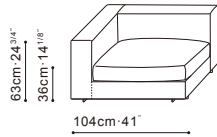

RAF Sofa
C0102202.3A
Extra Cover
B1002202.

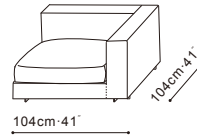

VOL. 0.75m³

	D	E	Q	R
Price (EURO)	1,400	1,665	1,690	2,015
Extra Cover (EURO)	375	640		

LAF Sofa
C0102203.3A
Extra Cover
B1002203.

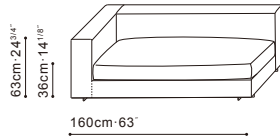

RAF Sofa
C0102204.3A
Extra Cover
B1002204.

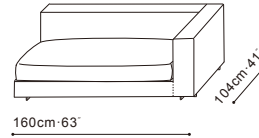

VOL. 1.15m³

Sofa can rotate 90 degrees to create a chaise piece.

	D	E	Q	R
Price (EURO)	1,775	2,040	2,260	2,725
Extra Cover (EURO)	490	755		

LAF Chaise
C0102206.3A
Extra Cover
B1002206.

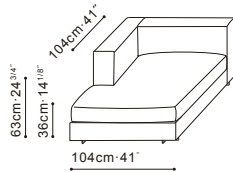

RAF Chaise
C0102205.3A
Extra Cover
B1002205.

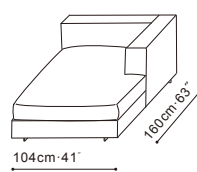

VOL. 1.15m³

	D	E	Q	R
Price (EURO)	1,725	1,990	2,195	2,625
Extra Cover (EURO)	465	730		

Armless Sofa
C0102207.3A
Extra Cover
B1002207.

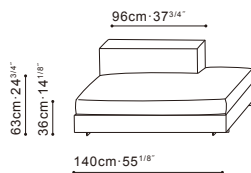

Armless Sofa
C0102208.3A
Extra Cover
B1002208.

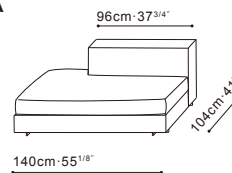

VOL. 1.0m³

	D	E	Q	R
Price (EURO)	1,500	1,775	1,900	2,295
Extra Cover (EURO)	400	675		

Armless Sofa
C0102209.3A
 Extra Cover
B1002209.

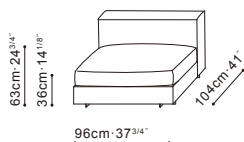

VOL. 0.7m³

	D	E	Q	R
Price (EURO)	1,290	1,465	1,545	1,725
Extra Cover (EURO)	350	525		

Armless Sofa
C0102210.3A
 Extra Cover
B1002210.



VOL. 0.8m³

	D	E	Q	R
Price (EURO)	1,375	1,650	1,740	1,870
Extra Cover (EURO)	375	640		

Ottoman
C0102211.3A
 Extra Cover
B1002211.

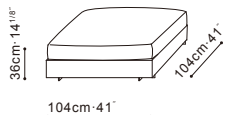

VOL. 0.4m³

	D	E	Q	R
Price (EURO)	1,150	1,325	1,400	1,575
Extra Cover (EURO)	315	490		

Cushion
C0802201.
 Extra Cover
B8002201.



	D	E	Q	R
Price (EURO)	200	265	400	480
Extra Cover (EURO)	115	180	315	395

Cushion
C0802202.
 Extra Cover
B8002202.



	D	E	Q	R
Price (EURO)	175	225	370	440
Extra Cover (EURO)	115	165	310	380

CLOUDS

Cushion
C0802203.
 Extra Cover
B8002203.



	D	E	Q	R
Price (EURO)	165	190	310	370
Extra Cover (EURO)	100	126	245	305

Cushion
C0802204.
 Extra Cover
B8002204.

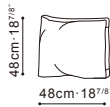

	D	E	Q	R
Price (EURO)	100	115	150	180
Extra Cover (EURO)	60	75	110	140

SOFA CRESCENT



- Available in various Lounge Chair, Sofa, Sectional, and Ottoman configurations
- Available in Fabric or Leather options. Fabric covers removable on Velcro

Construction:

Frame

- Solid birch wood and plywood frame with MDF reinforcement, paired with cross-woven elastic webbing, covered with polyurethane foam
- Grey fabric lining applied over foam for fabric upholstery, leather upholstery uses a polyester fiber layer instead

Cushion

- Seat and back cushions consist of channeled feather down and polyester fiber padding with high-resilient polyurethane foam center insert
- Throw cushion C0802105 filled with feather down
- All cushions have hidden zipper closing

Leg

- Alloyed die-casted legs in black metallic paint with plastic glides

N.B.: Please be mindful the back thickness is thinner than the arm thickness when creating configurations

SOFA CRESCENT

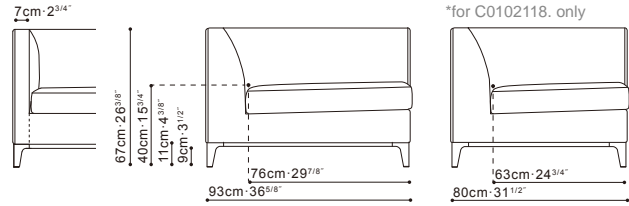

Armchair
C0102118.3A
Extra Cover
B1002118.00

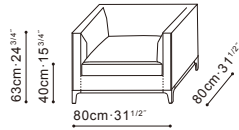

VOL. 0.4m³

	D	E	Q	R
Price (EURO)	1,290	1,500	1,570	1,725
Extra Cover (EURO)	400	610		

Two Seater Sofa
C0102119.3A
Extra Cover
B1002119.00

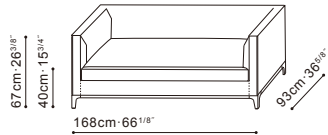

VOL. 1.05m³

	D	E	Q	R
Price (EURO)	2,125	2,390	2,480	2,985
Extra Cover (EURO)	625	890		

Two Seater Sofa
C0102102.3A
Extra Cover
B1002102.00

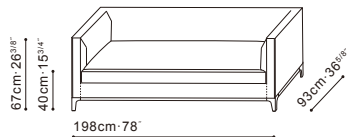

VOL. 1.2m³

	D	E	Q	R
Price (EURO)	2,300	2,575	2,805	3,345
Extra Cover (EURO)	715	990		

Two Seater Sofa
C0102103.3A
Extra Cover
B1002103.00

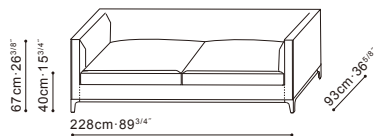

VOL. 1.4m³

	D	E	Q	R
Price (EURO)	2,525	2,790	3,095	3,705
Extra Cover (EURO)	750	1,015		

CRESCENT

LAF Sofa
C0102104.3A
 Extra Cover
B1002104.00

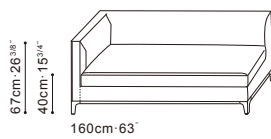

RAF Sofa
C0102105.3A
 Extra Cover
B1002105.00

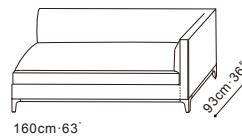

VOL. 1.0m³

	D	E	Q	R
Price (EURO)	1,950	2,210	2,300	2,770
Extra Cover (EURO)	490	750		

LAF Chaise
C0102110.3A
 Extra Cover
B1002110.00

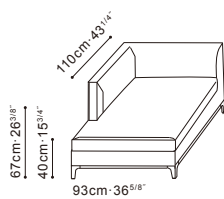

RAF Chaise
C0102111.3A
 Extra Cover
B1002111.00

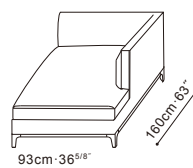

VOL. 1.0m³

	D	E	Q	R
Price (EURO)	1,900	2,175	2,260	2,655
Extra Cover (EURO)	465	740		

Ottoman
C0102117.3A
 Extra Cover
B1002117.00

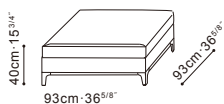

VOL. 0.3m³

	D	E	Q	R
Price (EURO)	1,240	1,465	1,495	1,575
Extra Cover (EURO)	375	600		

Cushion
C0802101.00
 Extra Cover
B8002101.00

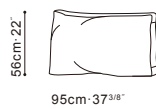

	D	E	Q	R
Price (EURO)	200	275	320	380
Extra Cover (EURO)	115	190	235	295

Cushion
C0802102.00
 Extra Cover
B8002102.00

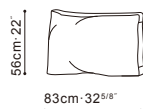

	D	E	Q	R
Price (EURO)	175	225	275	335
Extra Cover (EURO)	100	150	200	260

CRESCENT

Cushion

C0802103.00

Extra Cover

B8002103.00

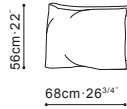

	D	E	Q	R
Price (EURO)	165	190	245	290
Extra Cover (EURO)	100	125	180	225

Cushion

C0802104.00

Extra Cover

B8002104.00

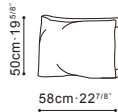

	D	E	Q	R
Price (EURO)	125	165	205	250
Extra Cover (EURO)	75	115	155	200

Cushion

C0802105.00

Extra Cover

B8002105.00



	D	E	Q	R
Price (EURO)	100	115	150	180
Extra Cover (EURO)	60	75	110	140

SOFA EAST-WEST

Designed by Axel Enthoven



- Available in Lounge Chair, Sofa, and Sectional configurations
- Armrest and backrest available in Leather only, covers not removable; Seat and back cushions available in Fabric or Leather options, fabric covers removable on Velcro; the armrests and backrests of C01H0818 and C01H0819 need to be unscrewed in order for covers to be removed

Construction:

Frame

- Solid birch wood wide armrest frame with plywood and MDF reinforcement, covered with polyurethane foam and polyester fiber
- Steel frame for detachable narrow armrest and backrest with a piping running along the edge, covered with polyurethane foam and polyester fiber
- Sofa base comes standard with pre-set metal connectors

Cushion

- Seat cushions consist of solid birch bases with plywood and MDF reinforcement, paired with cross-woven elastic webbing, sinuous and balance springs, topped with high-resilient polyurethane foam and polyester fiber
- Trapezoid back cushions consist of channeled feather down and polyester fiber padding with high-resilient polyurethane foam center insert
- Throw cushion C08TYK01 and arm cushion C08H0105 filled with feather down and polyester fiber
- All cushions have hidden zipper closing

Leg

- Steel legs in grey metallic paint with plastic glides

SOFA EAST-WEST

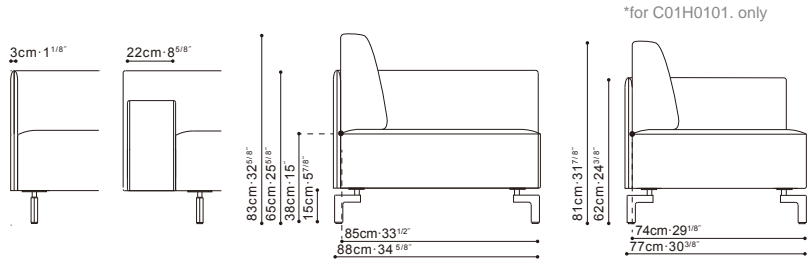

Armchair
C01H0101.34
Seat & Back Cushion Cover
B10H0101.00

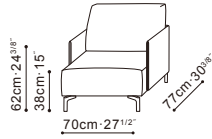

VOL. 0.4m³

	D	E	Q+D	Q+E	R+D	R+E	Q	R
Price (EURO)			1,740	1,815	1,975	2,065	2,020	2,300
Extra Cover (EURO)	275	365						

Two Seater Sofa
C01H0102.34
Seat & Back Cushion Cover
B10H0102.00

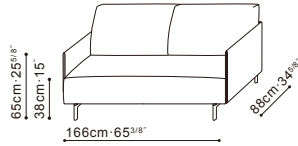

VOL. 1.1m³

	D	E	Q+D	Q+E	R+D	R+E	Q	R
Price (EURO)			2,770	2,890	3,165	3,290	3,165	3,800
Extra Cover (EURO)	400	515						

Three Seater Sofa
C01H0103.34
Seat & Back Cushion Cover
B10H0103.00

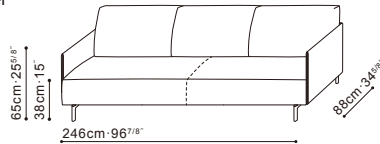

VOL. 2.0m³

	D	E	Q+D	Q+E	R+D	R+E	Q	R
Price (EURO)			3,610	3,770	4,165	4,315	4,255	5,100
Extra Cover (EURO)	515	675						

Three Seater Sofa
C01H0104.34
Seat & Back Cushion Cover
B10H0104.00

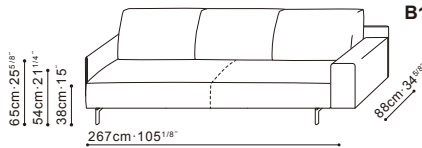

Three Seater Sofa
C01H0105.34
Seat & Back Cushion Cover
B10H0105.00

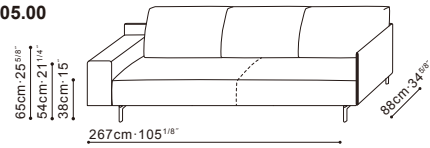

VOL. 2.1m³

	D	E	Q+D	Q+E	R+D	R+E	Q	R
Price (EURO)			3,845	4,005	4,440	4,590	4,470	5,350
Extra Cover (EURO)	515	675						

Three Seater Sofa
C01H0106.34
 Seat & Back Cushion Cover
B10H0106.00

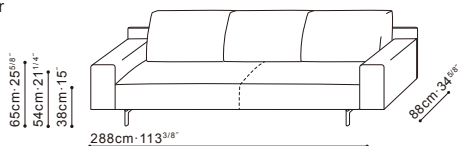

VOL. 2.25m³

	D	E	Q+D	Q+E	R+D	R+E	Q	R
Price (EURO)			4,080	4,240	4,715	4,875	4,685	5,600
Extra Cover (EURO)	515	675						

LAF Sofa
C01H0108.34
 Seat & Back Cushion Cover
B10H0108.00



RAF Sofa
C01H0109.34
 Seat & Back Cushion Cover
B10H0109.00

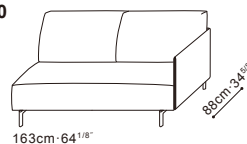

VOL. 0.95m³

	D	E	Q+D	Q+E	R+D	R+E	Q	R
Price (EURO)			2,495	2,615	2,850	2,975	2,925	3,525
Extra Cover (EURO)	400	515						

LAF Sofa
C01H0110.34
 Seat & Back Cushion Cover
B10H0110.00

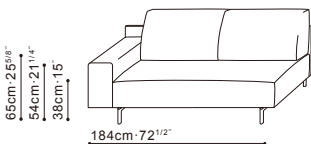

RAF Sofa
C01H0111.34
 Seat & Back Cushion Cover
B10H0111.00

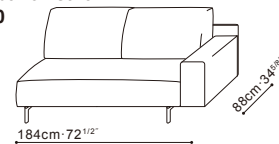

VOL. 1.05m³

	D	E	Q+D	Q+E	R+D	R+E	Q	R
Price (EURO)			2,730	2,850	3,125	3,250	3,130	3,765
Extra Cover (EURO)	400	515						

LAF Chaise
C01H0116.34
 Seat & Back Cushion Cover
B10H0116.00

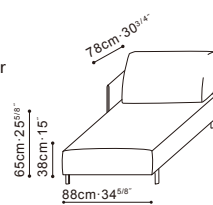

RAF Chaise
C01H0117.34
 Seat & Back Cushion Cover
B10H0117.00

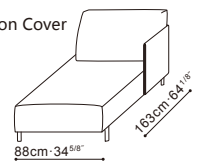

VOL. 0.95m³

	D	E	Q+D	Q+E	R+D	R+E	Q	R
Price (EURO)			2,135	2,215	2,450	2,575	2,570	3,100
Extra Cover (EURO)	365	475						

LAF Curved Chaise
C01H0118.34
 Seat & Back Cushion Cover
B10H0118.00

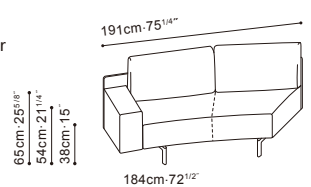

RAF Curved Chaise
C01H0119.34
 Seat & Back Cushion Cover
B10H0119.00

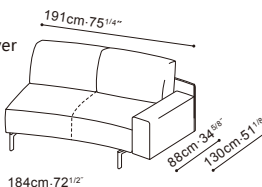

VOL. 1.45m³

	D	E	Q+D	Q+E	R+D	R+E	Q	R
Price (EURO)			2,835	2,950	3,265	3,380	3,300	3,965
Extra Cover (EURO)	445	555						

EAST-WEST

Cushion
C08H0103.00
 Extra Cover
B80H0103.00

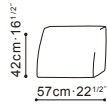

Optional cushion for sectional sofa corner

	D	E	Q	R
Price (EURO)	125	140	225	265
Extra Cover (EURO)	65	80	165	205

Regular Cushion
C08TYK01.00
 Extra Cover
B80TYK01.00

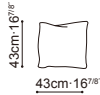

	D	E	F	Q	R
Price (EURO)	75	85	90	95	120
Extra Cover (EURO)	50	60	65	70	95

Cushion
C08H0105.00
 Extra Cover
B80H0105.00

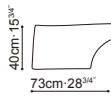

Optional cushion for sofa narrow armrests

	D	E	Q	R
Price (EURO)	75	90	140	165
Extra Cover (EURO)	50	65	115	140

SOFA EASYTIME



- Available in two depths, in various Lounge Chair, Sofa, Armless Sofa, Sectional, and Ottoman configurations
- Available in Fabric or Leather options. Fabric covers removable on Velcro

Construction:

Frame

- Solid birch wood frame with MDF and plywood reinforcement, seat paired with cross-woven elastic webbing
- Frame padded with polyurethane foam. Grey fabric lining applied over foam for fabric upholstery, leather upholstery uses a polyester fiber layer instead

Cushion

- Seat cushions consist of high-resilient polyurethane foam, topped with compartmented feather down and polyester fiber
- Back cushions consist of channeled feather down and polyester fiber padding with high-resilient polyurethane foam center insert
- Throw cushion C08F0904 filled with feather down
- Throw cushion C08TYK01 filled with feather down and polyester fiber
- All cushions have hidden zipper closing

Leg

- Steel legs in black metallic paint with plastic glides

SOFA EASYTIME

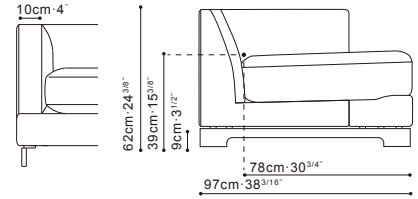

Armchair
C01F0901.3A
Extra Cover
B10F0901.00

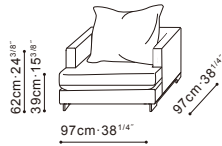

VOL. 0.6m³

	D	E	Q	R
Price (EURO)	1,640	1,815	1,940	2,265
Extra Cover (EURO)	440	615		

Two Seater Sofa
C01F0902.3A
Extra Cover
B10F0902.00

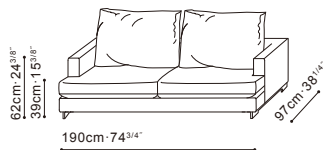

VOL. 1.0m³

	D	E	Q	R
Price (EURO)	2,390	2,615	3,015	3,590
Extra Cover (EURO)	665	890		

Two Seater Sofa
C01F0903.3A
Extra Cover
B10F0903.00

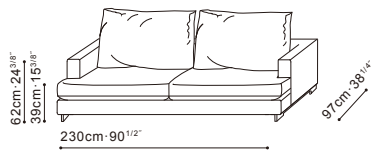

VOL. 1.35m³

	D	E	Q	R
Price (EURO)	2,790	3,065	3,550	4,230
Extra Cover (EURO)	800	1,075		

Three Seater Sofa
C01F0904.3A
Extra Cover
B10F0904.00

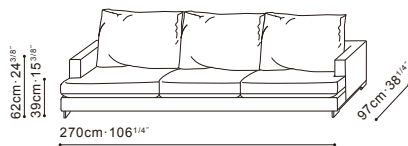

VOL. 1.55m³

	D	E	Q	R
Price (EURO)	3,275	3,550	4,195	4,985
Extra Cover (EURO)	975	1,250		

LAF Sofa
C01F0905.3A
 Extra Cover
B10F0905.00



RAF Sofa
C01F0906.3A
 Extra Cover
B10F0906.00

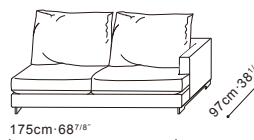

VOL. 1.05m³

	D	E	Q	R
Price (EURO)	2,215	2,390	2,835	3,375
Extra Cover (EURO)	625	800		

LAF Sofa
C01F0907.3A
 Extra Cover
B10F0907.00

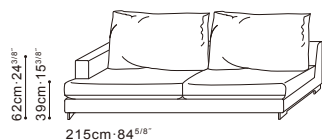

RAF Sofa
C01F0908.3A
 Extra Cover
B10F0908.00

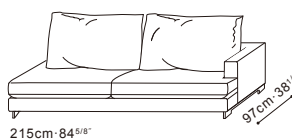

VOL. 1.25m³

	D	E	Q	R
Price (EURO)	2,575	2,790	3,260	3,870
Extra Cover (EURO)	750	965		

LAF Chaise
C01F0909.3A
 Extra Cover
B10F0909.00

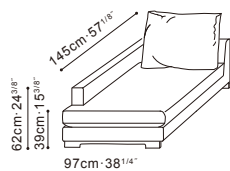

RAF Chaise
C01F0910.3A
 Extra Cover
B10F0910.00

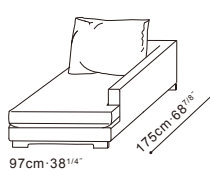

VOL. 1.05m³

	D	E	Q	R
Price (EURO)	2,175	2,350	2,805	3,345
Extra Cover (EURO)	600	775		

LAF Chaise
C01F0911.3A
 Extra Cover
B10F0911.00



RAF Chaise
C01F0912.3A
 Extra Cover
B10F0912.00

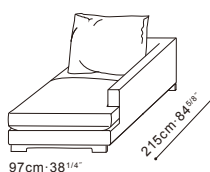

VOL. 1.25m³

	D	E	Q	R
Price (EURO)	2,475	2,700	3,125	3,735
Extra Cover (EURO)	715	940		

Corner Sofa
C01F0913.3A
 Extra Cover
B10F0913.00

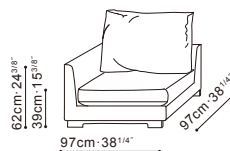

VOL. 0.6m³

	D	E	Q	R
Price (EURO)	1,550	1,725	1,830	2,115
Extra Cover (EURO)	425	600		

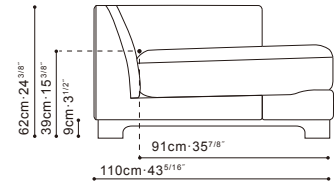

EASYTIME

Armless Sofa
C01F0929.3A
 Extra Cover
B10F0929.00

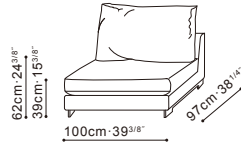

VOL. 0.65m³

	D	E	Q	R
Price (EURO)	1,600	1,775	1,905	2,230
Extra Cover (EURO)	425	600		

Ottoman
C01F0914.3A
 Extra Cover
B10F0914.00

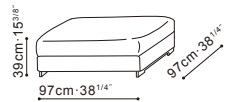

VOL. 0.4m³

	D	E	Q	R
Price (EURO)	1,325	1,465	1,530	1,620
Extra Cover (EURO)	375	515		

Armchair
C01F0915.3A
 Extra Cover
B10F0915.00

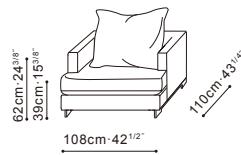

VOL. 0.85m³

	D	E	Q	R
Price (EURO)	1,690	1,865	2,050	2,375
Extra Cover (EURO)	465	640		

Two Seater Sofa
C01F0916.3A
 Extra Cover
B10F0916.00

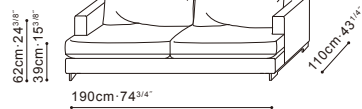

VOL. 1.3m³

	D	E	Q	R
Price (EURO)	2,440	2,665	3,130	3,705
Extra Cover (EURO)	690	915		

Two Seater Sofa
C01F0917.3A
 Extra Cover
B10F0917.00

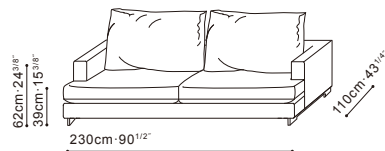

VOL. 1.55m³

	D	E	Q	R
Price (EURO)	2,840	3,100	3,665	4,345
Extra Cover (EURO)	825	1,085		

Three Seater Sofa
C01F0918.3A
 Extra Cover
B10F0918.00

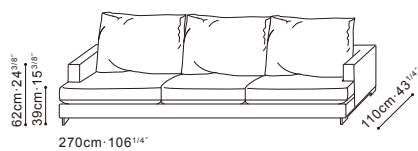

VOL. 1.85m³

	D	E	Q	R
Price (EURO)	3,325	3,590	4,310	5,100
Extra Cover (EURO)	1,000	1,265		

LAF Sofa
C01F0919.3A
 Extra Cover
B10F0919.00

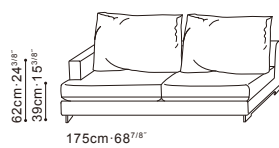

RAF Sofa
C01F0920.3A
 Extra Cover
B10F0920.00

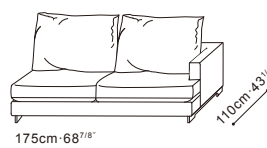

VOL. 1.2m³

	D	E	Q	R
Price (EURO)	2,265	2,440	2,940	3,480
Extra Cover (EURO)	640	815		

LAF Sofa
C01F0921.3A
 Extra Cover
B10F0921.00

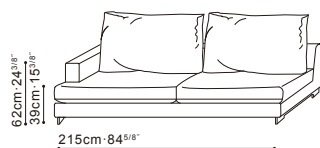

RAF Sofa
C01F0922.3A
 Extra Cover
B10F0922.00

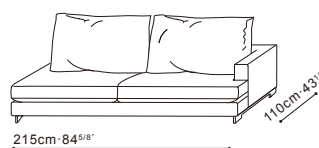

VOL. 1.45m³

	D	E	Q	R
Price (EURO)	2,615	2,840	3,375	3,985
Extra Cover (EURO)	775	1,000		

LAF Chaise
C01F0923.3A
 Extra Cover
B10F0923.00

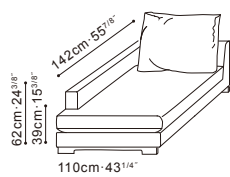

RAF Chaise
C01F0924.3A
 Extra Cover
B10F0924.00

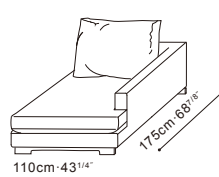

VOL. 1.2m³

	D	E	Q	R
Price (EURO)	2,215	2,390	2,905	3,445
Extra Cover (EURO)	625	800		

LAF Chaise
C01F0925.3A
 Extra Cover
B10F0925.00

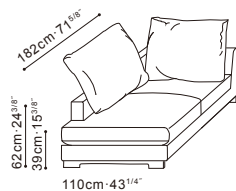

RAF Chaise
C01F0926.3A
 Extra Cover
B10F0926.00

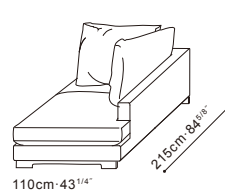

VOL. 1.45m³

	D	E	Q	R
Price (EURO)	2,615	2,840	3,375	3,985
Extra Cover (EURO)	775	1,000		

EASYTIME

Corner Sofa
C01F0927.3A
 Extra Cover
B10F0927.00

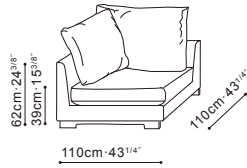

VOL. 0.8m³

	D	E	Q	R
Price (EURO)	1,900	2,090	2,195	2,590
Extra Cover (EURO)	600	790		

Armless Sofa
C01F0930.3A
 Extra Cover
B10F0930.00

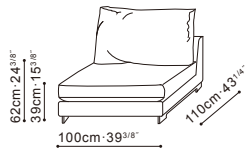

VOL. 0.7m³

	D	E	Q	R
Price (EURO)	1,640	1,815	1,940	2,265
Extra Cover (EURO)	440	615		

Ottoman
C01F0928.3A
 Extra Cover
B10F0928.00

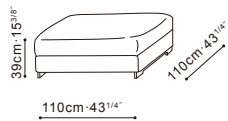

VOL. 0.5m³

	D	E	Q	R
Price (EURO)	1,410	1,550	1,630	1,790
Extra Cover (EURO)	400	540		

Cushion
C08F0904.00
 Extra Cover
B80F0904.00



	D	E	Q	R
Price (EURO)	100	115	190	220
Extra Cover (EURO)	65	80	155	185

Regular Cushion
C08TYK01.00
 Extra Cover
B80TYK01.00



	D	E	F	Q	R
Price (EURO)	75	85	90	95	120
Extra Cover (EURO)	50	60	65	70	95

SOFA ELAN

(New)



- An upgraded version to the ELAN collection, providing a shallower depth
- Modular design with Arm Sofa, Armless Sofa, Corner Sofa, and Chaise in various widths to create flexible configurations
- Certain sofa components consist of wood and FU Eco Leather sofa table, unique to the Elan collection (Please see Specs for details)
- Available in Fabric, Leather, or Fabric/Leather Combo options. Fabric covers removable on Velcro

Construction:

Frame

- Steel seat, backrest and armrest frame with MDF and plywood reinforcement, covered with polyurethane foam and modelling foam
- Grey fabric lining applied over foam for fabric upholstery, leather upholstery uses a polyester fiber layer instead
- Sofa base comes standard with pre-set metal connectors

Cushion

- Seat cushions consist of solid birch with MDF and plywood bases, paired with cross-woven elastic webbing, sinuous and balance springs, topped with high-resilient polyurethane foam and polyester fiber
- Back cushions consist of channeled feather down and polyester fiber padding with high-resilient polyurethane foam center insert
- Throw cushions filled with feather down and polyester fiber
- All cushions have hidden zipper closing

Sofa Table

- Drawer comes with invisible drawer runners with dampers

Leg

- Inset black plastic (ABS) legs giving the sofa a “floating” design

SOFA ELAN (New)

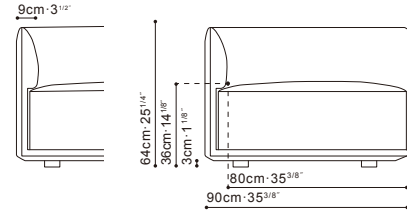

LAF Sofa
C01F0201.00
Extra Cover
B10F0201.00

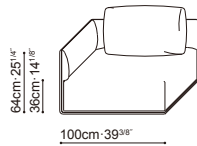

RAF Sofa
C01F0202.00
Extra Cover
B10F0202.00

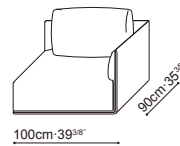

VOL. 0.85m³

	D	E	Q+D	Q+E	R+D	R+E	Q	R
Price (EURO)	1,550	1,690	1,700	1,725	1,845	1,925	1,795	2,085
Extra Cover (EURO)	440	580						

Armless Sofa
C01F0203.00
Extra Cover
B10F0203.00

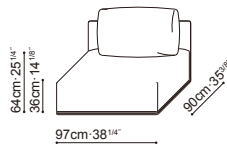

VOL. 0.85m³

	D	E	Q+D	Q+E	R+D	R+E	Q	R
Price (EURO)	1,325	1,465	1,480	1,520	1,640	1,725	1,580	1,870
Extra Cover (EURO)	350	490						

LAF Sofa
C01F0217.00
Extra Cover
B10F0217.00

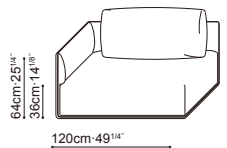

RAF Sofa
C01F0218.00
Extra Cover
B10F0218.00

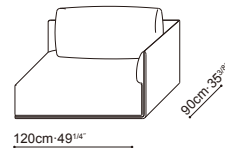

VOL. 1.0m³

	D	E	Q+D	Q+E	R+D	R+E	Q	R
Price (EURO)	1,775	1,900	1,920	1,955	2,115	2,200	2,050	2,410
Extra Cover (EURO)	490	615						

LAF Sofa
C01F0204.00
Extra Cover
B10F0204.00

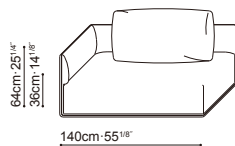

RAF Sofa
C01F0205.00
Extra Cover
B10F0205.00

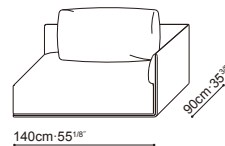

VOL. 1.15m³

	D	E	Q+D	Q+E	R+D	R+E	Q	R
Price (EURO)	1,990	2,125	2,125	2,205	2,365	2,435	2,340	2,770
Extra Cover (EURO)	575	710						

ELAN (New)

LAF Sofa
C01F0206.00
 Extra Cover
B10F0206.00

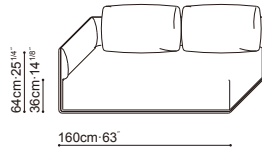

RAF Sofa
C01F0207.00
 Extra Cover
B10F0207.00

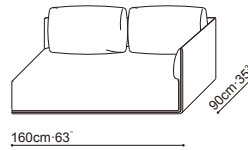

VOL. 1.3m³

	D	E	Q+D	Q+E	R+D	R+E	Q	R
Price (EURO)	2,265	2,390	2,410	2,445	2,605	2,685	2,655	3,120
Extra Cover (EURO)	665	790						

Armless Sofa
C01F0208.00
 Extra Cover
B10F0208.00

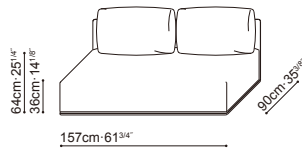

VOL. 1.3m³

	D	E	Q+D	Q+E	R+D	R+E	Q	R
Price (EURO)	2,040	2,175	2,200	2,240	2,400	2,485	2,440	2,870
Extra Cover (EURO)	600	735						

Armless Sofa
C01F0209.00
 Extra Cover
B10F0209.00

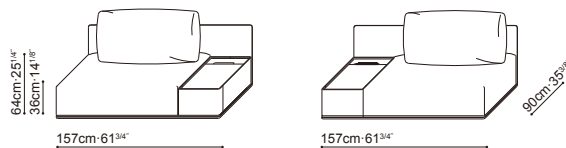

VOL. 1.3m³

Price doesn't include sofa table B12F0216.

	D	E	Q+D	Q+E	R+D	R+E	Q	R
Price (EURO)	1,690	1,815	1,830	1,875	1,995	2,080	1,940	2,265
Extra Cover (EURO)	465	590						

LAF Sofa
C01F0210.00
 Extra Cover
B10F0210.00

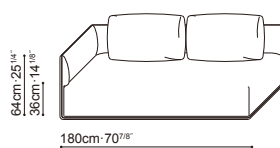

RAF Sofa
C01F0211.00
 Extra Cover
B10F0211.00

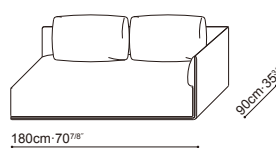

VOL. 1.45m³

	D	E	Q+D	Q+E	R+D	R+E	Q	R
Price (EURO)	2,475	2,615	2,630	2,675	2,875	2,960	2,905	3,445
Extra Cover (EURO)	715	855						

LAF Sofa
C01F0212.00
 Extra Cover
B10F0212.00

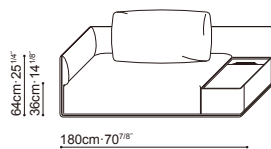

RAF Sofa
C01F0213.00
 Extra Cover
B10F0213.00

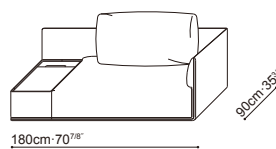

VOL. 1.45m³

Price doesn't include sofa table B12F0216.

	D	E	Q+D	Q+E	R+D	R+E	Q	R
Price (EURO)	2,090	2,215	2,245	2,325	2,485	2,555	2,480	2,950
Extra Cover (EURO)	625	750						

ELAN (New)

LAF Chaise
C01F0214.00
 Extra Cover
B10F0214.00

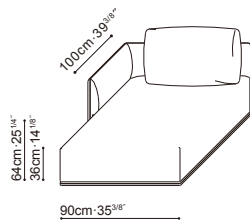

RAF Chaise
C01F0215.00
 Extra Cover
B10F0215.00

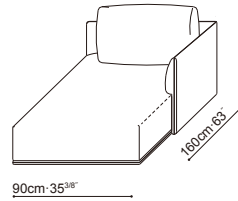

VOL. 1.3m³

	D	E	Q+D	Q+E	R+D	R+E	Q	R
Price (EURO)	2,090	2,215	2,245	2,325	2,485	2,555	2,480	2,950
Extra Cover (EURO)	625	750						

Corner Sofa
C01F0219.00
 Extra Cover
B10F0219.00

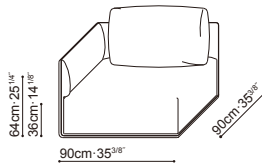

VOL. 0.75m³

Corner sofa can serve as either a LAF or RAF sofa.

	D	E	Q+D	Q+E	R+D	R+E	Q	R
Price (EURO)	1,415	1,550	1,565	1,605	1,725	1,805	1,685	1,970
Extra Cover (EURO)	400	535						

Sofa Table
B12F0216.00

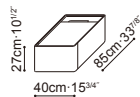

Grey Oak + Driftwood + FU-03
 B12F0216.00.0000

Grey Oak + Charcoal + FU-06
 B12F0216.00.0001

675

Natural Oak + Burlywood + FU-03
 B12F0216.00.0002

VOL. 0.2m³

Cushion
C08F0204.00
 Extra Cover
B80F0204.00

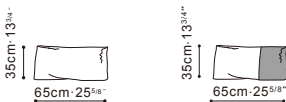

The shadow part is leather, the rest is fabric.

	D	E	Q+D	Q+E	R+D	R+E	Q	R
Price (EURO)	80	90	130	145	160	175	160	190
Extra Cover (EURO)	40	50	90	105	120	135	120	150

Regular Cushion
C08TYK01.00
 Extra Cover
B80TYK01.00



	D	E	F	Q	R
Price (EURO)	75	85	90	95	120
Extra Cover (EURO)	50	60	65	70	95

SOFA EPIC



- Modular design with Armless Sofa, Armless Angled Sofa, attachable Sofa Arm, and Ottoman to create flexible configurations
- Wood and FU Eco Leather combined armrest and sofa table are unique to the Epic series
- A compatible wireless charger on sofa table B12H0214 is an easy-to-use solution for daily life
- Available in Fabric or Eco Leather options. Fabric covers removable on Velcro

Construction:

Frame

- Solid birch wood frame with MDF and plywood reinforcement, seat frame paired with cross-woven elastic webbing, equipped with sinuous and balance springs
- Frame covered with polyurethane foam and polyester fiber. Grey fabric lining applied over polyester fiber for fabric upholstery
- Sofa base comes standard with pre-set metal connectors

Cushion

- Seat cushion consists of high-resilient polyurethane foam, topped with compartmented feather down and polyester fiber
- Back cushions consist of channeled feather down and polyester fiber padding with high-resilient polyurethane foam center insert
- Throw cushion C08H0205 filled with feather down and polyester fiber
- Bolsters filled with polyurethane foam and polyester fiber
- All cushions have hidden zipper closing

Sofa table

- Drawer comes with invisible push-pull drawer runner with dampers

Leg

- Steel legs in black metallic paint with plastic glides

SOFA EPIC

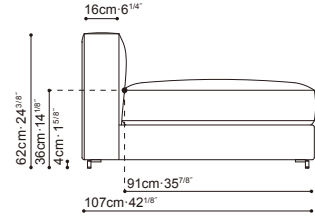

Armless Sofa
C01H0201.3A
Extra Cover
B10H0201.00

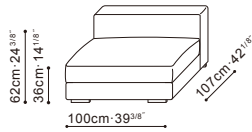

VOL. 0.8m³

	D	E	Q	R
Price (EURO)	1,415	1,540	1,660	1,975
Extra Cover (EURO)	400	525		

Armless Sofa
C01H0202.3A
Extra Cover
B10H0202.00

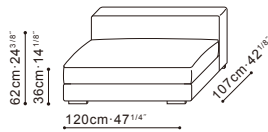

VOL. 0.95m³

	D	E	Q	R
Price (EURO)	1,590	1,715	1,835	2,190
Extra Cover (EURO)	440	565		

Armless Sofa
C01H0203.3A
Extra Cover
B10H0203.00

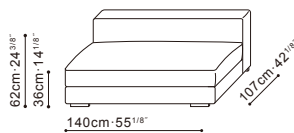

VOL. 1.1m³

	D	E	Q	R
Price (EURO)	1,765	1,890	2,080	2,465
Extra Cover (EURO)	490	615		

Armless Sofa
C01H0204.3A
Extra Cover
B10H0204.00

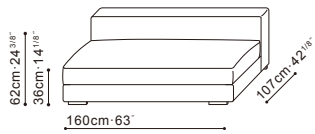

VOL. 1.25m³

	D	E	Q	R
Price (EURO)	1,975	2,115	2,395	2,890
Extra Cover (EURO)	525	665		

Armless Corner Sofa
C01H0205.3A
 Extra Cover
B10H0205.00

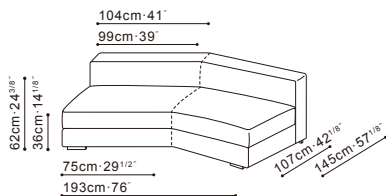

VOL. 2.05m³

	D	E	Q	R
Price (EURO)	3,075	3,250	3,485	4,225
Extra Cover (EURO)	665	840		

Armless Sofa
C01H0206.3A
 Extra Cover
B10H0206.00

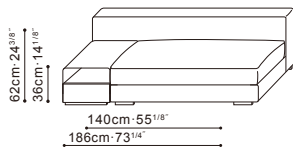

Armless Sofa
C01H0207.3A
 Extra Cover
B10H0207.00

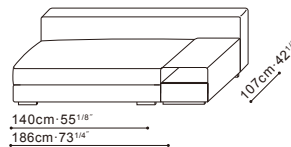

VOL. 1.45m³

Price doesn't include B12H0214

	D	E	Q	R
Price (EURO)	1,890	2,025	2,215	2,675
Extra Cover (EURO)	525	660		

Armless Sofa
C01H0208.3A
 Extra Cover
B10H0208.00

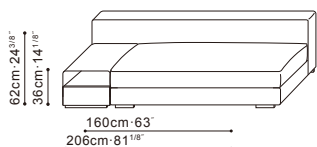

Armless Sofa
C01H0209.3A
 Extra Cover
B10H0209.00

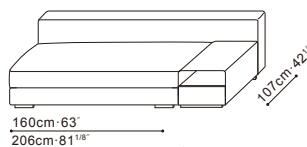

VOL. 1.6m³

Price doesn't include B12H0214

	D	E	Q	R
Price (EURO)	2,115	2,250	2,570	3,100
Extra Cover (EURO)	575	710		

Ottoman
C01H0210.3A
 Extra Cover
B10H0210.00

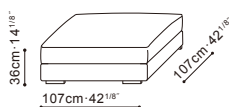

VOL. 0.55m³

	D	E	Q	R
Price (EURO)	1,325	1,450	1,510	1,825
Extra Cover (EURO)	350	475		

Sofa Armrest
B12H0211.3A
 Extra Cover
B10H0211.00

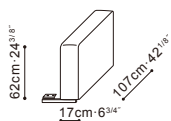

VOL. 0.15m³

Interchangeable armrest, can be added to either side

	D	E	Q	R
Price (EURO)	490	525	615	740
Extra Cover (EURO)	150	185		

EPIC

Sofa Armrest
B12H0212.3A
 Extra Cover
B10H0212.00

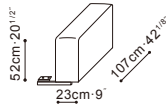

VOL. 0.15m³

Interchangeable armrest, can be added to either side

	D	E	Q	R
Price (EURO)	490	525	615	740
Extra Cover (EURO)	150	185		

Sofa Armrest
B12H0213.3A

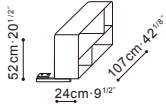

Interchangeable armrest, can be added to either side

Grey Oak + FU-02
 B12H0213.3A.FU02

Grey Oak + FU-03
 B12H0213.3A.FU03

915

Grey Oak + FU-05
 B12H0213.3A.FU05

Grey Oak + FU-06
 B12H0213.3A.FU06

VOL. 0.3m³

Sofa Table
B12H0214.3A

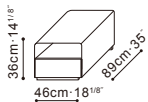

Suitable for C01H0206,C01H0207,C01H0208 and C01H0209 only

Grey Oak + FU-02
 B12H0214.3A.FU02

Grey Oak + FU-03
 B12H0214.3A.FU03

1,335

Grey Oak + FU-05
 B12H0214.3A.FU05

Grey Oak + FU-06
 B12H0214.3A.FU06

VOL. 0.3m³

Sofa Table
B12H0215.3A

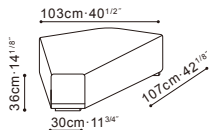

Grey Oak + FU-02
 B12H0215.3A.FU02

Grey Oak + FU-03
 B12H0215.3A.FU03

2,175

Grey Oak + FU-05
 B12H0215.3A.FU05

Grey Oak + FU-06
 B12H0215.3A.FU06

VOL. 0.65m³

Cushion
C08H0201.00
 Extra Cover
B80H0201.00

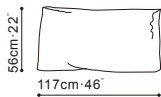

	D	E	Q	R
Price (EURO)	190	215	345	415
Extra Cover (EURO)	100	125	255	325

Cushion

C08H0202.00

Extra Cover

B80H0202.00

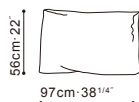

	D	E	Q	R
Price (EURO)	175	200	305	365
Extra Cover (EURO)	100	125	230	290

Cushion

C08H0203.00

Extra Cover

B80H0203.00



	D	E	Q	R
Price (EURO)	165	190	260	315
Extra Cover (EURO)	90	115	185	240

Cushion

C08H0204.00

Extra Cover

B80H0204.00

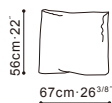

	D	E	Q	R
Price (EURO)	140	165	245	290
Extra Cover (EURO)	75	100	180	225

Cushion

C08H0205.00

Extra Cover

B80H0205.00



	D	E	Q	R
Price (EURO)	75	90	160	190
Extra Cover (EURO)	50	65	135	165

Bolster

C08H0206.00

Extra Cover

B80H0206.00

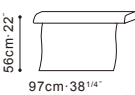

Optional bolster for C08H0201

	D	E	Q	R
Price (EURO)	100	115	165	190
Extra Cover (EURO)	65	80	130	155

Bolster

C08H0207.00

Extra Cover

B80H0207.00

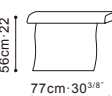

Optional bolster for C08H0202

	D	E	Q	R
Price (EURO)	90	100	150	175
Extra Cover (EURO)	65	75	125	150

Bolster

C08H0208.00

Extra Cover

B80H0208.00

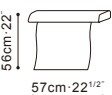

Optional bolster for C08H0203

	D	E	Q	R
Price (EURO)	75	90	140	165
Extra Cover (EURO)	50	65	115	140

SOFA MODA



- Available in Lounge Chair, Sofa, and Sectional configurations
- Available in Fabric, Leather or Fabric/Leather Combo options. Covers removable on zippers

Construction:

Frame

- Steel seat frame paired with cross-woven elastic webbing, sinuous springs, and balance springs
- Plywood base edge binding, covered in black Eco Leather FC-11
- Outer steel panels covered in polyurethane foam, fabric lining and various leather upholstery (please see configuration info for details)
- Sectional sofa base comes standard with pre-set metal connectors

Cushion

- Detachable armrest, backrest and seat cushions filled with high-resilient polyurethane foam, wrapped in compartmented feather down and polyester fiber
- All cushions have hidden zipper closing

Leg

- Steel legs in black metallic paint with plastic glides

SOFA MODA

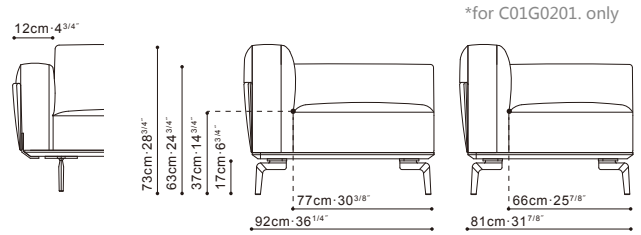

Armchair
C01G0201.3A
Extra Cover
B10G0201.00

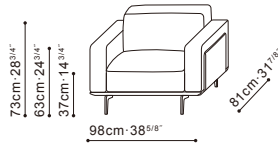

VOL. 0.55m³

	D	E	Q+D	Q+E	R+D	R+E	Q	R
Price (EURO)	2,035	2,175	2,285	2,360	2,505	2,575	2,435	2,685
Extra Cover (EURO)	400	540	650	725	870	940	800	1,050

Two Seater Sofa
C01G0203.3A
Extra Cover
B10G0203.00

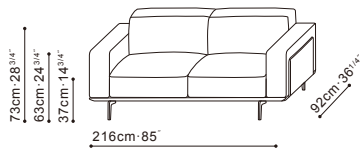

VOL. 1.2m³

	D	E	Q+D	Q+E	R+D	R+E	Q	R
Price (EURO)	3,640	3,850	3,870	3,950	4,210	4,320	4,455	4,885
Extra Cover (EURO)	800	1,010	1,030	1,110	1,370	1,480	1,615	2,045

Three Seater Sofa
C01G0204.3A
Extra Cover
B10G0204.00

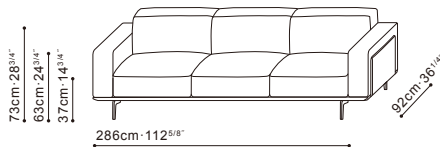

VOL. 1.6m³

	D	E	Q+D	Q+E	R+D	R+E	Q	R
Price (EURO)	4,565	4,825	4,845	4,875	5,245	5,390	5,560	6,100
Extra Cover (EURO)	1,025	1,285	1,305	1,335	1,705	1,850	2,020	2,560

LAF Sofa
C01G0205.3A
Extra Cover
B10G0205.00

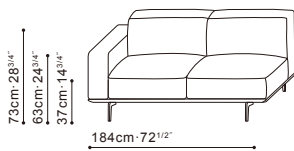

RAF Sofa
C01G0206.3A
Extra Cover
B10G0206.00

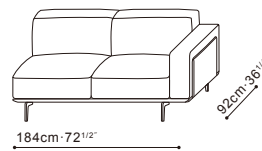

VOL. 1.05m³

	D	E	Q+D	Q+E	R+D	R+E	Q	R
Price (EURO)	2,925	3,100	3,115	3,135	3,320	3,435	3,480	3,840
Extra Cover (EURO)	715	890	905	925	1,110	1,225	1,270	1,630

LAF Chaise
C01G0207.3A
 Extra Cover
B10G0207.00

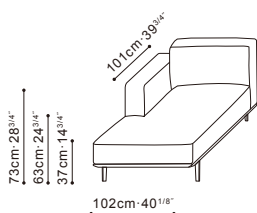

RAF Chaise
C01G0208.3A
 Extra Cover
B10G0208.00

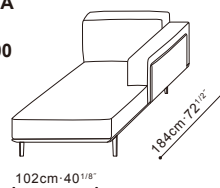

VOL. 1.15m³

	D	E	Q+D	Q+E	R+D	R+E	Q	R
Price (EURO)	2,790	2,960	2,965	2,975	2,995	3,095	3,200	3,525
Extra Cover (EURO)	665	835	840	850	870	970	1,075	1,400

LAF Sofa
C01G0209.3A
 Extra Cover
B10G0209.00

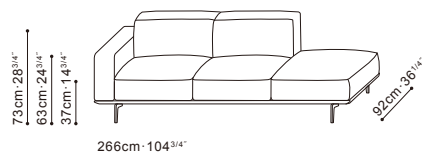

RAF Sofa
C01G0210.3A
 Extra Cover
B10G0210.00

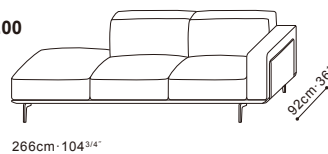

VOL. 1.45m³

	D	E	Q+D	Q+E	R+D	R+E	Q	R
Price (EURO)	3,725	3,940	3,950	4,060	4,320	4,425	4,555	4,985
Extra Cover (EURO)	840	1,055	1,065	1,175	1,435	1,540	1,670	2,100

Information on Moda Sofa Series

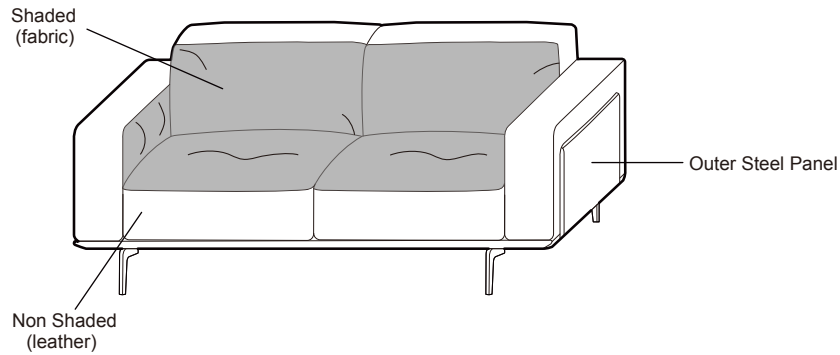

When selecting fabric and leather combinations, the leather choice will be used in the non-shaded area while the fabric choice will be used in the shaded area. Please refer to the catalogue for sample image.

Information on Moda Leather Outer Steel Panels:

Default Panel Selection

Panel Leather Color	Sofa Upholstery (No Shaded Area)
FC-11 Black	<p>Fabric: COCO-01, GEM-02, GOYA-03/04, GRACE-04/05/08, GERRY-01, LINEAR-01/02/03/04, LUXE-02/03/04/06, MONET-03/04/05, MORGAN-01, NEMO-03, PANO-01, PLUSH-03/04, SKY-02, TRIO-02</p> <p>Leather: Q-14, R-02/04/05/15, RS-23/26/27/28/32/33/34/36, T-22/23</p>
FC-08 Camel	<p>Fabric: 07238-2A, 3335-01, A1416-2B/2D, A646-2A, DALE-01, GEM-01, GERRY-03, GOYA-01/02, GRACE-01/02, MONET-02, MORGAN-02, NEMO-01/02, PLUSH-01/02, SKY-01, TRIO-01</p> <p>Leather: Q-11/12/13, R-12, RS-20/22/24/25/30/31/35, T-21</p>

- FC panel colors can be designated with no upcharge
- If FC panel code is not specified on order, default panel will be used
- Panels cannot be produced in T Leather

Upcharge

- For custom panels in Q grade, upcharge would be €40 per panel
- For custom panels in R grade, upcharge would be €50 per panel

SOFA NATURE



- Features optional black metallic painted steel outer frame with yellow or black leather strap
- Modular design with Arm Sofa, Armless Sofa, and Ottoman in two depths to create flexible configurations
- Available in Fabric or Leather options. Fabric covers removable on Velcro (armrests and backrests need to be unscrewed in order for covers to be removed)

Construction:

Frame

- Plywood and solid birch wood frame with MDF reinforcement, paired with cross-woven elastic webbing
- Backrest and Armrest frame padded with polyurethane foam, feather down, and polyester fiber
- Seat frame covered with polyurethane foam. Grey fabric lining applied over foam for fabric upholstery, leather upholstery uses a polyester fiber layer instead
- Sofa base comes standard with pre-set metal connectors

Cushion

- Seat cushions consist of high-resilient polyurethane foam, topped with compartmented feather down and polyester fiber
- Back cushion C08E0601 consists of channeled feather down and polyester fiber padding with high-resilient polyurethane foam center insert
- Back and throw cushions filled with feather down and polyester fiber
- All cushions have hidden zipper closing

Leg

- Steel legs in black metallic paint with plastic glides

SOFA NATURE

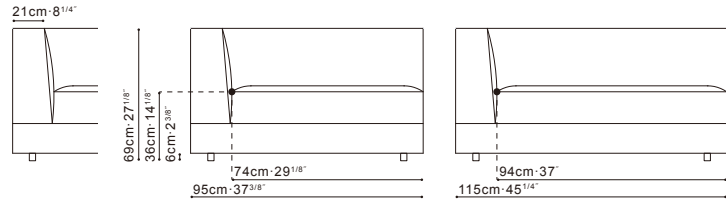

LAF Sofa
C01E0601.3A
Extra Cover
B10E0601.00

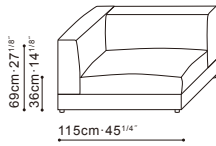

RAF Sofa
C01E0602.3A
Extra Cover
B10E0602.00

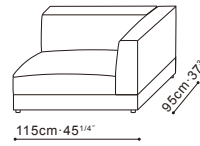

VOL. 0.8m³

	D	E	Q	R
Price (EURO)	1,550	1,690	2,015	2,410
Extra Cover (EURO)	400	540		

Armless Sofa
C01E0603.3A
Extra Cover
B10E0603.00

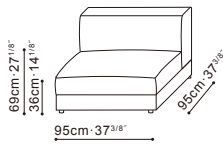

VOL. 0.65m³

	D	E	Q	R
Price (EURO)	1,325	1,465	1,475	1,725
Extra Cover (EURO)	350	490		

LAF Sofa
C01E0604.3A
Extra Cover
B10E0604.00

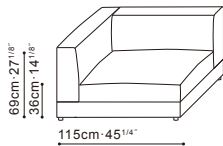

RAF Sofa
C01E0605.3A
Extra Cover
B10E0605.00

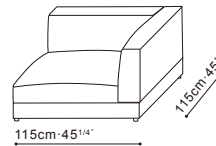

VOL. 1.0m³

	D	E	Q	R
Price (EURO)	1,725	1,865	2,295	2,725
Extra Cover (EURO)	425	565		

Armless Sofa
C01E0606.3A
Extra Cover
B10E0606.00

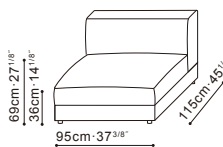

VOL. 0.8m³

	D	E	Q	R
Price (EURO)	1,465	1,600	1,690	2,015
Extra Cover (EURO)	375	510		

Ottoman
C01E0607.3A
 Extra Cover
B10E0607.00

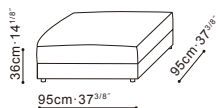

VOL. 0.45m³

	D	E	Q	R
Price (EURO)	1,215	1,325	1,380	1,475
Extra Cover (EURO)	315	425		

Ottoman
C01E0608.3A
 Extra Cover
B10E0608.00

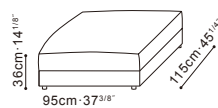

VOL. 0.5m³

	D	E	Q	R
Price (EURO)	1,315	1,415	1,480	1,620
Extra Cover (EURO)	340	440		

Cushion
C08E0601.00
 Extra Cover
B80E0601.00



	D	E	Q	R
Price (EURO)	220	255	300	360
Extra Cover (EURO)	145	180	225	285

Cushion
C08E0602.00
 Extra Cover
B80E0602.00



	D	E	Q	R
Price (EURO)	150	190	235	280
Extra Cover (EURO)	90	130	175	220

Regular Cushion
C08TYK01.00
 Extra Cover
B80TYK01.00



	D	E	F	Q	R
Price (EURO)	75	85	90	95	120
Extra Cover (EURO)	50	60	65	70	95

NATURE

Sofa Outer Frame/
Black Leather Strap
B12E0609.3A.0001

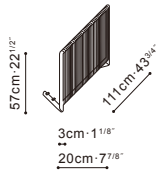

530

VOL. 0.2m³

Sofa Outer Frame/
Black Leather Strap
B12E0610.3A.0001

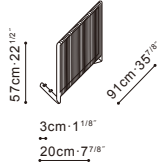

490

VOL. 0.15m³

SOFA RUBIX



- Features unique inlay black piping design
- Modular design with Armless Sofa, Armless Chaise, attachable Sofa Arm, and Ottoman to create flexible configurations
- Available in Fabric or Leather options. Fabric covers removable on Velcro. Movable Backrest C08C0107 only available in leather
- Attachable sofa arm B12C0145 and B12C0146 available in marble, oak and FU Eco Leather Combo (Please see Specs for details)

Construction:

Frame

- Solid birch wood armrest, backrest structure with MDF and plywood reinforcement, covered with polyurethane foam, modelling foam, feather down and polyester fiber
- Tight seat design consists of solid birch with MDF and plywood base, paired with cross-woven elastic webbing, sinuous and balance springs, and high-resilient polyurethane foam topped with feather down and polyester fiber
- Steel-framed movable backrest C08C0107, covered by polyurethane foam and modelling foam, with skid resistance base cloth underneath
- Sofa base comes standard with pre-set metal connectors (please refer to the Information page for details)

Cushion

- Back cushion C08C0104 and throw cushion C08C0105 filled with feather down and polyester fiber
- Bolster C08C0106 filled with polyurethane foam and polyester fiber
- All cushions have hidden zipper closing

Leg

- Inset black plastic (ABS) legs giving the sofa a “floating” design

SOFA RUBIX

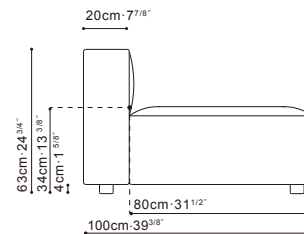

Armless Sofa
C01C0131.00
Extra Cover
B10C0131.00

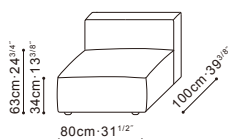

VOL. 0.6m³

	D	E	Q	R
Price (EURO)	1,055	1,145	1,185	1,435
Extra Cover (EURO)	330	420		

Armless Sofa
C01C0132.00
Extra Cover
B10C0132.00

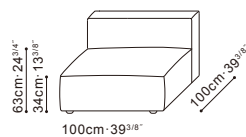

VOL. 0.75m³

	D	E	Q	R
Price (EURO)	1,190	1,275	1,365	1,650
Extra Cover (EURO)	350	435		

Armless Sofa
C01C0133.00
Extra Cover
B10C0133.00

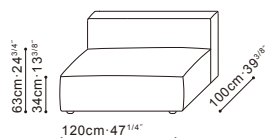

VOL. 0.85m³

	D	E	Q	R
Price (EURO)	1,320	1,410	1,545	1,865
Extra Cover (EURO)	375	465		

Armless Sofa
C01C0134.00
Extra Cover
B10C0134.00

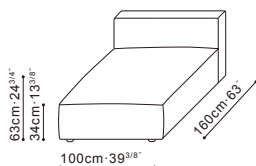

VOL. 1.2m³

	D	E	Q	R
Price (EURO)	1,540	1,670	1,865	2,225
Extra Cover (EURO)	420	550		

Ottoman
C01C0135.00
 Extra Cover
B10C0135.00

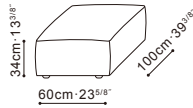

VOL. 0.3m³

	D	E	Q	R
Price (EURO)	835	925	945	970
Extra Cover (EURO)	265	355		

Ottoman
C01C0136.00
 Extra Cover
B10C0136.00

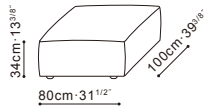

VOL. 0.35m³

	D	E	Q	R
Price (EURO)	925	1,010	1,070	1,150
Extra Cover (EURO)	285	370		

Ottoman
C01C0137.00
 Extra Cover
B10C0137.00

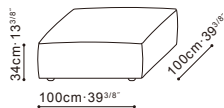

VOL. 0.4m³

	D	E	Q	R
Price (EURO)	1,010	1,100	1,115	1,330
Extra Cover (EURO)	310	400		

Ottoman
C01C0138.00
 Extra Cover
B10C0138.00

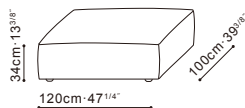

VOL. 0.5m³

	D	E	Q	R
Price (EURO)	1,100	1,190	1,255	1,510
Extra Cover (EURO)	330	420		

Ottoman
C01C0139.00
 Extra Cover
B10C0139.00

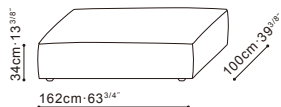

VOL. 0.65m³

	D	E	Q	R
Price (EURO)	1,275	1,365	1,510	1,830
Extra Cover (EURO)	375	465		

RUBIX

Ottoman
C01C0140.00
 Extra Cover
B10C0140.00

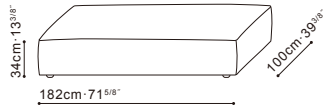

VOL. 0.75m³

	D	E	Q	R
Price (EURO)	1,365	1,450	1,650	2,010
Extra Cover (EURO)	395	480		

LAF Low Armrest
B12C0141.3A
 Extra Cover
B10C0141.00



RAF Low Armrest
B12C0142.3A
 Extra Cover
B10C0142.00

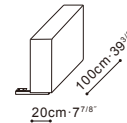

VOL. 0.15m³

	D	E	Q	R
Price (EURO)	440	485	575	680
Extra Cover (EURO)	130	175		

LAF High Armrest
B12C0143.3A
 Extra Cover
B10C0143.00



RAF High Armrest
B12C0144.3A
 Extra Cover
B10C0144.00

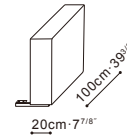

VOL. 0.2m³

	D	E	Q	R
Price (EURO)	485	530	645	755
Extra Cover (EURO)	155	200		

LAF Armrest
B12C0145.3A

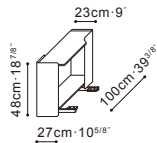

Carrara Marble + Grey Oak + FU-02
 B12C0145.3A.0000

Carrara Marble + Grey Oak + FU-03
 B12C0145.3A.0001

Carrara Marble + Natural Oak + FU-03
 B12C0145.3A.0002

815

Galaxy Grey Marble + Grey Oak + FU-02
 B12C0145.3A.0003

Galaxy Grey Marble + Grey Oak + FU-03
 B12C0145.3A.0004

VOL. 0.35m³

RAF Armrest
B12C0146.3A

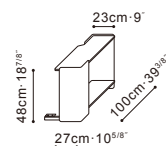

Carrara Marble + Grey Oak + FU-02
 B12C0146.3A.0000

Carrara Marble + Grey Oak + FU-03
 B12C0146.3A.0001

Carrara Marble + Natural Oak + FU-03
 B12C0146.3A.0002

815

Galaxy Grey Marble + Grey Oak + FU-02
 B12C0146.3A.0003

Galaxy Grey Marble + Grey Oak + FU-03
 B12C0146.3A.0004

VOL. 0.35m³

Cushion
C08C0104.00
 Extra Cover
B80C0104.00

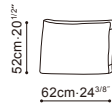

	D	E	Q	R
Price (EURO)	160	200	250	295
Extra Cover (EURO)	80	120	170	215

Cushion
C08C0105.00
 Extra Cover
B80C0105.00

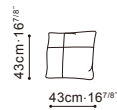

	D	E	Q	R
Price (EURO)	100	120	125	155
Extra Cover (EURO)	60	80	85	115

Bolster
C08C0106.00
 Extra Cover
B80C0106.00

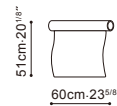

	D	E	Q	R
Price (EURO)	80	100	155	185
Extra Cover (EURO)	40	60	115	145



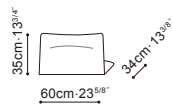





Movable Backrest
C08C0107.00

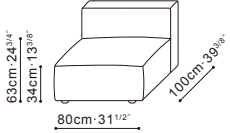
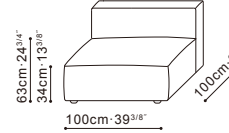
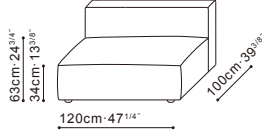
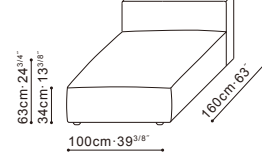

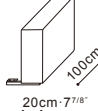
VOL. 0.1m³

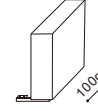
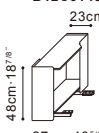
	Q	R
Price (EURO)	370	465

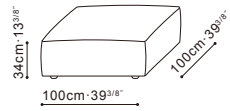
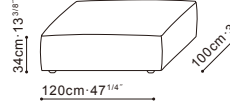
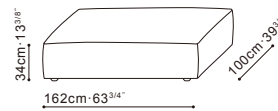
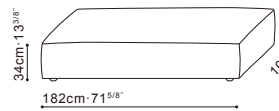
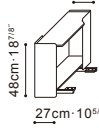
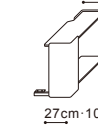
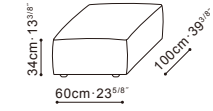
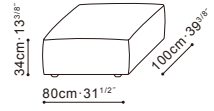
Information on Rubix Sofa Series

Sofa Module	Matchable Armrest
<p>C01C0131.</p>  <p>C01C0132.</p>  <p>C01C0133.</p>  <p>C01C0134.</p> 	<p>B12C0141.</p>  <p>B12C0142.</p>  <p>B12C0143.</p>  <p>B12C0144.</p>  <p>B12C0145.</p>  <p>B12C0146.</p> 
<p>C01C0137.</p>  <p>C01C0138.</p>  <p>C01C0139.</p>  <p>C01C0140.</p> 	<p>B12C0145.</p>  <p>B12C0146.</p> 
<p>C01C0135.</p>  <p>C01C0136.</p> 	

Metal Connectors

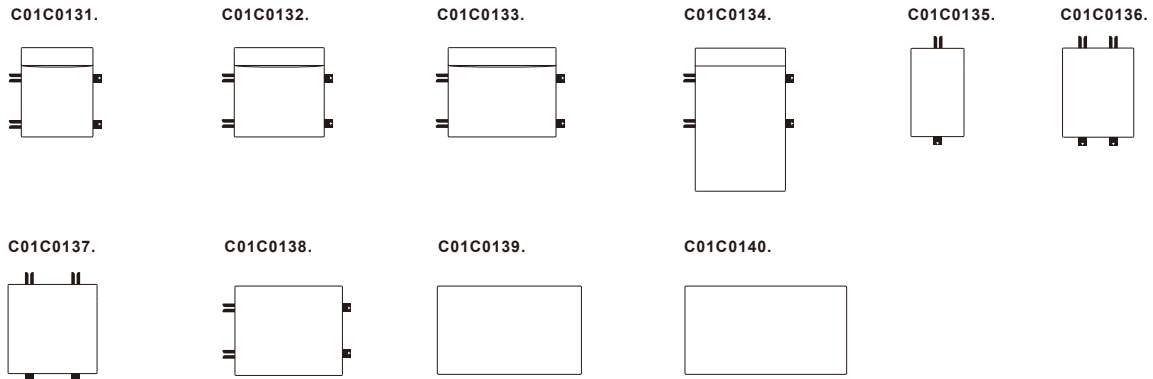

SOFA WAKE



- Modular design with Sofa, Arm Sofa, Armless Sofa, Chaise, and Daybed in varying widths to create flexible configurations
- Certain sofa components consist of sofa table, unique to the Wake collection
- Available in Fabric, Leather, or Fabric/Leather Combo options. Fabric covers removable on Velcro

Construction:

Frame

- Plywood and solid birch wood frame with MDF reinforcement, paired with cross-woven elastic webbing, covered with polyurethane foam
- Grey fabric lining applied over foam for fabric upholstery, leather upholstery uses a polyester fiber layer instead
- Sofa base comes standard with pre-set metal connectors

Cushion

- Seat cushions consist of high-resilient polyurethane foam, topped with feather down and polyester fiber
- Back and throw cushions filled with feather down and polyester fiber
- Bolster of daybed filled with polyurethane foam
- All cushions have hidden zipper closing

Leg

- Steel legs in black metallic paint with plastic glides

SOFA WAKE

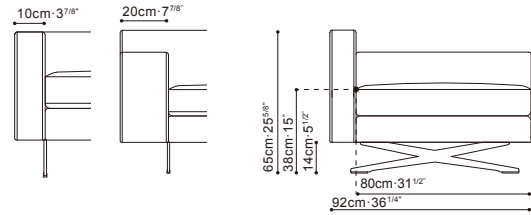

Armless Sofa
C01D0201.3A
Extra Cover
B10D0201.00

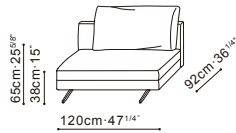

VOL. 0.7m³

	D	E	Q	R
Price (EURO)	1,725	1,865	1,935	2,330
Extra Cover (EURO)	440	580		

Armless Sofa
C01D0202.3A
Extra Cover
B10D0202.00

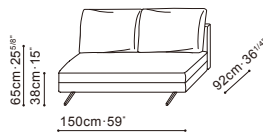

VOL. 0.85m³

	D	E	Q	R
Price (EURO)	2,040	2,215	2,370	2,835
Extra Cover (EURO)	540	715		

Armless Sofa
C01D0203.3A
Extra Cover
B10D0203.00

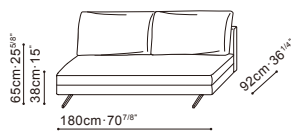

VOL. 1.0m³

	D	E	Q	R
Price (EURO)	2,300	2,475	2,760	3,300
Extra Cover (EURO)	665	840		

Two Seater Sofa
C01D0205.3A
Extra Cover
B10D0205.00

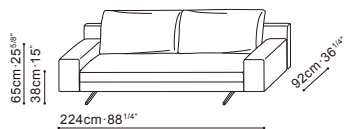

VOL. 1.3m³

	D	E	Q	R
Price (EURO)	2,700	2,875	3,405	4,050
Extra Cover (EURO)	840	1,015		

LAF Sofa
C01D0206.3A
 Extra Cover
B10D0206.00

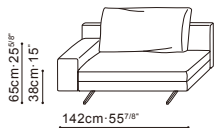

RAF Sofa
C01D0207.3A
 Extra Cover
B10D0207.00



VOL. 0.8m³

	D	E	Q	R
Price (EURO)	1,900	2,040	2,260	2,725

Extra Cover (EURO) 515 655

LAF Sofa
C01D0208.3A
 Extra Cover
B10D0208.00



RAF Sofa
C01D0209.3A
 Extra Cover
B10D0209.00

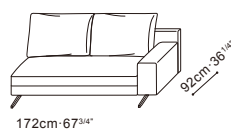

VOL. 0.95m³

	D	E	Q	R
Price (EURO)	2,215	2,390	2,690	3,230

Extra Cover (EURO) 600 775

LAF Sofa
C01D0210.3A
 Extra Cover
B10D0210.00



RAF Sofa
C01D0211.3A
 Extra Cover
B10D0211.00

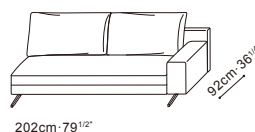

VOL. 1.1m³

	D	E	Q	R
Price (EURO)	2,475	2,665	3,095	3,705

Extra Cover (EURO) 725 915

Armless Sofa
C01D0212.3A
 Extra Cover
B10D0212.00

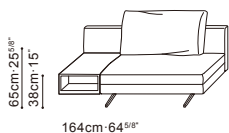

Armless Sofa
C01D0213.3A
 Extra Cover
B10D0213.00

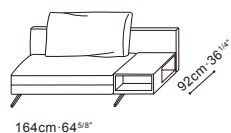

VOL. 0.95m³

Price doesn't include sofa table B12D0231.

	D	E	Q	R
Price (EURO)	1,815	1,950	2,115	2,545

Extra Cover (EURO) 465 600

Armless Sofa
C01D0214.3A
 Extra Cover
B10D0214.00

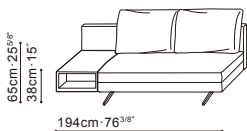

Armless Sofa
C01D0215.3A
 Extra Cover
B10D0215.00

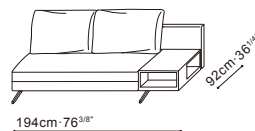

VOL. 1.1m³

Price doesn't include sofa table B12D0231.

	D	E	Q	R
Price (EURO)	2,125	2,300	2,550	3,050

Extra Cover (EURO) 575 750

WAKE

Armless Sofa
C01D0216.3A
 Extra Cover
B10D0216.00

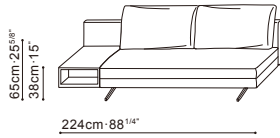

Armless Sofa
C01D0217.3A
 Extra Cover
B10D0217.00

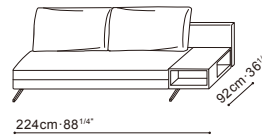

VOL. 1.25m³

Price doesn't include sofa table B12D0231.

	D	E	Q	R
Price (EURO)	2,390	2,575	2,950	3,525

Extra Cover (EURO) 690 875

LAF Sofa
C01D0218.3A
 Extra Cover
B10D0218.00

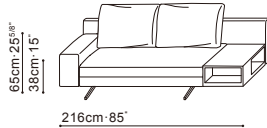

RAF Sofa
C01D0219.3A
 Extra Cover
B10D0219.00

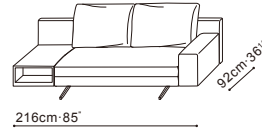

VOL. 1.4m³

Price doesn't include sofa table B12D0231.

	D	E	Q	R
Price (EURO)	2,300	2,475	2,760	3,300

Extra Cover (EURO) 665 840

LAF Sofa
C01D0220.3A
 Extra Cover
B10D0220.00

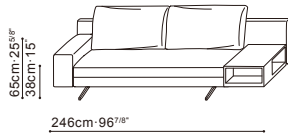

RAF Sofa
C01D0221.3A
 Extra Cover
B10D0221.00

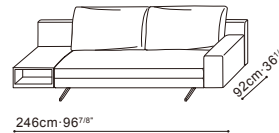

VOL. 1.55m³

Price doesn't include sofa table B12D0231.

	D	E	Q	R
Price (EURO)	2,575	2,750	3,225	3,870

Extra Cover (EURO) 750 925

LAF Chaise
C01D0222.3A
 Extra Cover
B10D0222.00

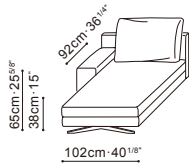

RAF Chaise
C01D0223.3A
 Extra Cover
B10D0223.00

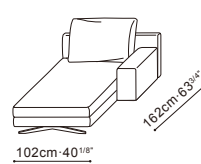

VOL. 1.0m³

	D	E	Q	R
Price (EURO)	2,040	2,215	2,370	2,835

Extra Cover (EURO) 540 715

Daybed
C01D0230.3A
 Extra Cover
B10D0230.00

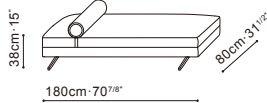

VOL. 0.55m³

	D	E	Q	R
Price (EURO)	1,640	1,775	1,820	1,905

Extra Cover (EURO) 425 560

Regular Cushion
C08TYK01.00
 Extra Cover
B80TYK01.00

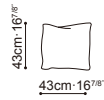

	D	E	F	Q	R
Price (EURO)	75	85	90	95	120
Extra Cover (EURO)	50	60	65	70	95

Sofa Table
B12D0231.00

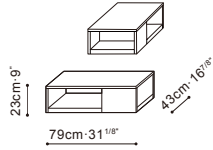

Grey Oak
 B12D0231.00.0000 250

Carrara Marble + Grey Oak
 B12D0231.00.0001 425 VOL. 0.15m³

SOFA BED

LOLA 091

SOFA BED LOLA



- A space-saver design offers 3 persons seating and 2 persons sleeping, bed (size 145*200cm) with a storage bag underneath
- Optional High Armrest and Low Armrest configurations, armrests interchangeable
- Upholstery default in LUXE-04 or LINEAR-01, covers removable on zipper

Construction:

Frame

- Steel seat, backrest frame paired with 16cm-thick pocket spring system, covered with high-resilient polyurethane foam, polyester fiber and fabric lining, (load bearing of 240KG)
- Auto steel un-folding mechanism in place for easy sofa to bed conversion
- Plywood armrests with MDF reinforcement, covered with polyurethane foam and fabric lining

Cushion

- Back cushions filled with feather down and polyester fiber, come with hidden zipper closing

Leg

- Black powder coated steel legs with plastic glides

SOFA BED LOLA

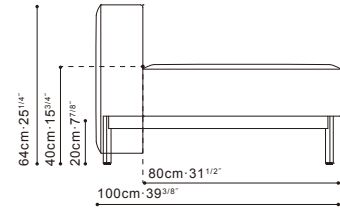

Sofa Bed
C01F0801.31
Extra Cover
B10F0801.00

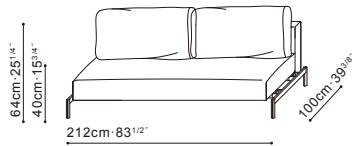

VOL. 0.85m³

It cannot be used individually and must be always matched with armrests.

D

Price (EURO) 2,650

Extra Cover (EURO) 555

High Armrest
B12F0802.00
Extra Cover
B10F0802.00

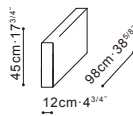

VOL. 0.1m³

D

Price (EURO) 265

Extra Cover (EURO) 55

Low Armrest
B12F0803.00
Extra Cover
B10F0803.00

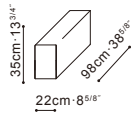

VOL. 0.15m³

D

Price (EURO) 265

Extra Cover (EURO) 55

C01F0801.+B12F0802.+B12F0803.

C01F0801.+B12F0802.×2

C01F0801.+B12F0803.×2

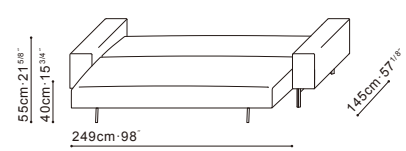
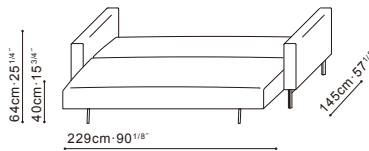
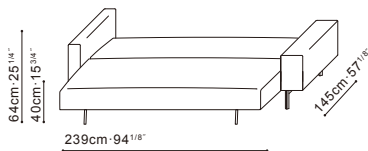
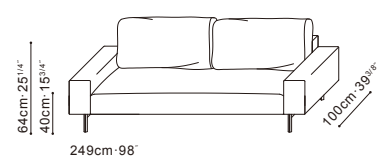
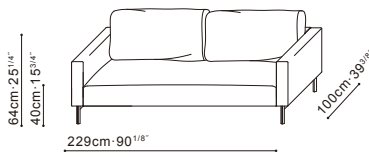
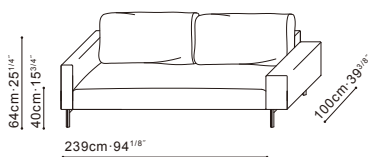

Armrests interchangeable

CHAIRS

AUSTEN	094
BAIANA	096
BALLET	098
COZI	100
DICE	102
EASE	104
ECHO	106
EMBRACE	108
ESSENCE	110
FLORA	112
LEAF	114
LEMAN	116
MING	118
NOBLE	120
PUCK	122
PUZZLE	124
QING	126
SOHO	128
VAST	130
VENUS	132
WALTZ PLUS	134
WING	136

CHAIR AUSTEN



- Seat and back cushions available in Fabric or Leather options, covers removable on zipper
- The upholstery on armrests and piping details are always same as the selected leather option on back and seat frame
- Solid birch wood inner frame for Lounge Chair, reinforced by MDF and plywood, seat paired with elastic webbing
- Solid birch wood back inner frame for Daybed, reinforced by MDF, steel seat inner frame equipped with elastic webbing and sinuous springs
- Seat and back inner frame covered with polyurethane foam and upholstered in FC Eco Leather or Leather
- Seat and back cushions consist of high-resilient polyurethane foam and compartmented feather down with polyester fiber top. Seat cushion zippered to the frame to avoid moving
- Black metallic painted steel outer frame with plastic glides

CHAIR AUSTEN

Lounge Chair
C02H0501.3A
Seat & Back Cushion Cover
B20H0501.00

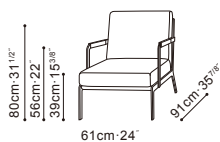

VOL. 0.5m³

	D	E	P+D	P+E	Q+D	Q+E	R+D	R+E	Q	R
Price (EURO)			1,240	1,275	1,315	1,350	1,465	1,500	1,480	1,725
Extra Cover (EURO)	115	165							355	465

LAF Lounge Chaise
C02H0503.3A
Seat & Back Cushion Cover
B20H0503.00

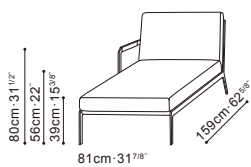

VOL. 1.05m³

	D	E	P+D	P+E	Q+D	Q+E	R+D	R+E	Q	R
Price (EURO)			1,840	1,915	2,025	2,100	2,215	2,290	2,150	2,540
Extra Cover (EURO)	440	515							640	850

RAF Lounge Chaise
C02H0502.3A
Seat & Back Cushion Cover
B20H0502.00

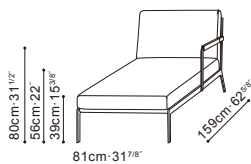

VOL. 1.05m³

	D	E	P+D	P+E	Q+D	Q+E	R+D	R+E	Q	R
Price (EURO)			1,840	1,915	2,025	2,100	2,215	2,290	2,150	2,540
Extra Cover (EURO)	440	515							640	850

CHAIR BAIANA

Designed by Alvaro Siza



- Available in Armless and Arm Dining Chair
- Available in Leather option only. Covers not removable
- Solid ash wood frame available in natural oak or grey oak finish
- Plywood seat covered with polyurethane foam and polyester fiber
- Legs come with Teflon glides; an extra set of felt pads included in the packaging

CHAIR BAIANA

Dining Chair
C02F0501.

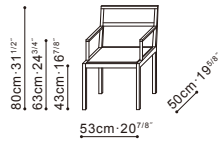

VOL. 0.45m³

	Q	R
Natural Oak C02F0501.08	350	365
Grey Oak C02F0501.07	350	365

Dining Chair
C02F0502.

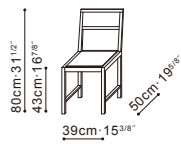

VOL. 0.3m³

	Q	R
Natural Oak C02F0502.08	335	350
Grey Oak C02F0502.07	335	350

CHAIR BALLET



- Available in Armless/Arm Dining Chair, Stool, Counter Stool, and Bar Stool
- Available in Fabric or Leather options. Covers not removable
- Metal backrest covered with rubber, integrally-molded polyurethane foam and polyester fiber, rubber armrests allow for slight firmness adjustment
- Metal seat frame with plywood reinforcement, paired with cross-woven elastic webbing, covered with integrally-molded polyurethane foam and polyester fiber
- 360 ° swivel bases for Chair C02F0305, C02F0306 and stool C02F0307
- Black metallic painted steel legs with felt pads

CHAIR BALLET

Dining Chair
C02F0303.3A



Price (EURO)

D 550 E 590 F 640 P 610 Q 655 R 705 VOL. 0.3m³

Dining Chair
C02F0304.3A

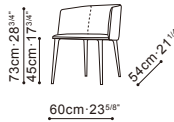

Price (EURO)

D 625 E 650 F 710 P 680 Q 720 R 785 VOL. 0.3m³

Swivel Dining Chair
C02F0305.3A



Price (EURO)

D 600 E 640 F 685 P 655 Q 710 R 760 VOL. 0.3m³

Swivel Dining Chair
C02F0306.3A



Price (EURO)

D 675 E 715 F 760 P 730 Q 775 R 845 VOL. 0.3m³

Swivel Stool
C02F0307.3A



Price (EURO)

D 300 E 325 F 345 P 340 Q 345 R 355 VOL. 0.1m³

Counter Stool
C02F0309.3A



Price (EURO)

D 650 E 690 F 750 P 715 Q 760 R 810 VOL. 0.35m³

Counter Stool
C02F0310.3A



Price (EURO)

D 725 E 765 F 805 P 775 Q 825 R 895 VOL. 0.35m³

Bar Stool
C02F0311.3A

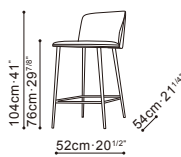

Price (EURO)

D 690 E 725 F 765 P 735 Q 795 R 845 VOL. 0.45m³

Bar Stool
C02F0312.3A



Price (EURO)

D 765 E 800 F 840 P 810 Q 860 R 925 VOL. 0.45m³

CHAIR COZI



- Available in Fabric or Leather options. Frame covers not removable
- Solid birch wood frame with MDF and plywood reinforcements, paired with cross-woven elastic webbing and sinuous springs, covered with polyurethane foam and fabric lining
- Seat cushion consists of high-resilient polyurethane foam, topped with compartmented feather down and polyester fiber
- Throw cushion filled with feather down
- Steel legs in black metallic paint with plastic glides

CHAIR COZI

Lounge Chair
C02H0601.3A

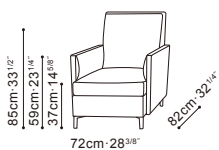

VOL. 0.5m³

	D	E	Q	R
Price (EURO)	1,025	1,115	1,375	1,690

Cushion
C08H0601.

Extra Cover
B80H0601.



	D	E	Q	R
Price (EURO)	65	75	110	125
Extra Cover (EURO)	40	50	85	100

OTTOMAN DICE



- Available in Fabric or Leather options. Fabric covers removable on Velcro
- Solid birch wood frame with plywood reinforcement, covered in polyurethane foam and polyester fiber
- Plastic glides installed at the bottom

OTTOMAN DICE

Ottoman
C0250310.00
 Extra Cover
B2050310.00

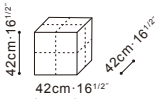

VOL. 0.2m³

	D	E	P	Q	R
Price (EURO)	265	290	315	360	415
Extra Cover (EURO)	75	100			

CHAIR EASE



- Available in Fabric or Leather options. Covers not removable
- Solid birch wood seat and backrest with plywood and MDF reinforcement, covered with high-resilient polyurethane foam and polyester fiber
- Metal and sinuous springs armrests allow slight firmness adjustment, covered with integral ly-molded polyurethane foam and polyester fiber
- Steel legs in grey metallic paint with plastic glides

CHAIR EASE

Lounge Chair
C02C0303.34

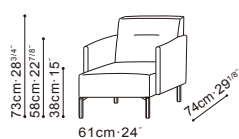

VOL. 0.3m³

	D	E	P	Q	R
Price (EURO)	890	925	1,100	1,280	1,400

Loveseat
C02C0304.34

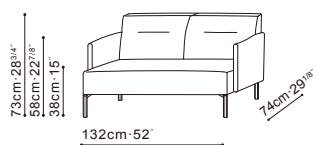

VOL. 0.65m³

	D	E	P	Q	R
Price (EURO)	1,240	1,325	1,550	1,760	2,040

CHAIR ECHO



- Available in Fabric or Leather options. Covers not removable
- Metal frame reinforced by MDF, plywood seat frame paired with cross-woven elastic webbing; all covered with high-resilient polyurethane foam and polyester fiber
- Chair cover comes with similar-colored zippers as a decoration
- Base with plastic (ABS) glides; an extra set of felt pads included in the packaging

CHAIR ECHO

Dining Chair
C02D0902.00



VOL. 0.3m³

	D	E	F	P	Q	R
Price (EURO)	595	630	820	805	985	1,170

CHAIR EMBRACE



- Available in Fabric or Leather options. Covers not removable
- Solid birch wood frame, curved plywood armrest and backrest with metal reinforcement, covered with polyurethane foam and polyester fiber. Seat frame paired with cross-woven elastic webbing and sinuous springs
- Seat cushions filled with high-resilient variable-density polyurethane foam and polyester fiber
- Steel legs in black metallic paint with plastic glides

CHAIR EMBRACE

Lounge Chair
C02D0601.3A

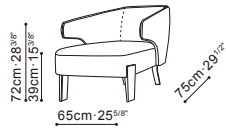

VOL. 0.35m³

	D	E	P	Q	R
Price (EURO)	965	1,025	1,140	1,275	1,475

Loveseat
C02D0602.3A

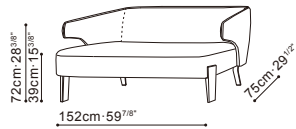

VOL. 0.75m³

	D	E	P	Q	R
Price (EURO)	1,425	1,515	1,750	1,995	2,315

CHAIR ESSENCE

Designed by Favaretto & Partners



- Available in Armless/Arm Dining Chair, and Lounge Chair
- Available in Leather option only. Covers not removable
- Solid ash wood frame available in grey oak finish
- ABS plastic seat and backrest for C02H0301 and C02H0302
- Curved plywood seat and backrest for C02H0303
- Seat and backrest frame covered with polyurethane foam
- Legs come with Teflon glides; an extra set of felt pads included in the packaging

CHAIR ESSENCE

Dining Chair
C02H0301.07



VOL. 0.3m³

	Q	R
Price (EURO)	605	675

Dining Chair
C02H0302.07

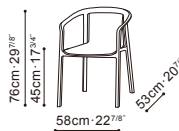

VOL. 0.35m³

	Q	R
Price (EURO)	705	775

Lounge Chair
C02H0303.07

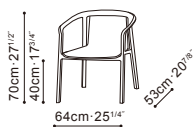

VOL. 0.4m³

	Q	R
Price (EURO)	805	910

CHAIR FLORA



- Available in Armless Dining Chair and Lounge Chair
- Available in Fabric or Leather options. Covers not removable
- Solid ash wood frame with plywood and MDF reinforcement, available in grey oak or natural oak finish
- Backrest and seat covered with polyurethane foam and polyester fiber
- Seat cushion of C0220011 consists of high-resilient polyurethane foam, topped with compartmented feather down
- Throw cushion filled with feather down
- Legs come with Teflon glides; an extra set of felt pads included in the packaging

CHAIR FLORA

Lounge Chair
C0220011.

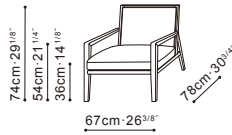

VOL. 0.45m³

Grey Oak
C0220011.07

	D	E	P	Q	R
Grey Oak C0220011.07	575	675	775	905	950

Natural Oak
C0220011.08

Natural Oak C0220011.08	575	675	775	905	950
-------------------------	-----	-----	-----	-----	-----

Dining Chair
C0220014.

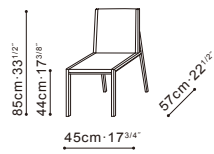

VOL. 0.25m³

Grey Oak
C0220014.07

	D	E	P	Q	R
Grey Oak C0220014.07	375	400	415	465	485

Natural Oak
C0220014.08

Natural Oak C0220014.08	375	400	415	465	485
-------------------------	-----	-----	-----	-----	-----

Cushion
C0820010.00
Extra Cover
B8020010.00

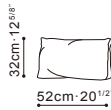

	D	E	P	Q	R
Price (EURO)	90	100	150	195	215
Extra Cover (EURO)	50	60	110	155	175

CHAIR LEAF



- Available in Leather option only. Covers not removable
- Solid ash wood frame available in grey oak finish
- Curved plywood seat and backrest covered with integrally-molded polyurethane foam
- Legs come with Teflon glides; an extra set of felt pads included in the packaging

CHAIR LEAF

Dining Chair
C02C1201.07

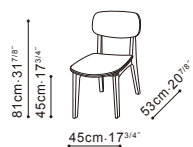

VOL. 0.25m³

	P	Q	R
Price (EURO)	500	550	590

CHAIR LEMAN



- Available in Fabric or Leather options. Covers not removable
- Black metallic painted steel frame comes with Teflon glides
- Steel seat and backrest frame, seat paired with elastic webbing and covered with polyurethane foam, backrest covered with modelling foam, all wrapped in polyester fiber
- Throw cushion filled with feather down

CHAIR LEMAN

Lounge Chair
C0255050.3A

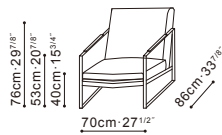

VOL. 0.2m³

	D	E	F	P	Q	R
Price (EURO)	975	1,015	1,180	1,140	1,210	1,340

Cushion
C0855052.00

Extra Cover
B8055052.00



	D	E	F	P	Q	R
Price (EURO)	100	115	125	155	190	220
Extra Cover (EURO)	65	80	90	120	155	185

CHAIR MING



- Available in Armless and Arm Dining Chair
- Available in Fabric or Leather options. Covers not removable
- Solid ash wood frame, available in grey oak finish
- Plastic backrest covered with integrally-molded polyurethane foam and polyester fiber
- Plywood seat for C02A1501 covered with polyurethane foam and polyester fiber
- Plastic-molded seat for C02A1502 paired with cross-woven elastic webbing, covered with polyurethane foam and polyester fiber
- Legs come with Teflon glides; an extra set of felt pads included in the packaging

CHAIR MING

Dining Chair
C02A1501.07

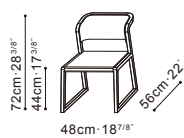

VOL. 0.25m³

	D	E	F	P	Q	R
Price (EURO)	440	465	490	485	490	500

Dining Chair
C02A1502.07

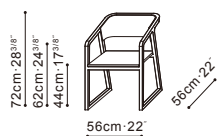

VOL. 0.3m³

	D	E	F	P	Q	R
Price (EURO)	475	500	540	525	565	625

CHAIR NOBLE



- Available in Fabric or Leather options. Covers removable on Velcro
- Compression-molded steel seat and backrest frame reinforced by solid birch wood and MDF, covered in polyurethane foam and fabric lining
- Seat cushion filled with high-resilient polyurethane foam
- Throw cushion filled with feather down and polyester fiber
- Steel legs in black metallic paint with plastic glides

CHAIR NOBLE

Lounge Chair
C02B0701.3A

Extra Cover
B20B0701.00

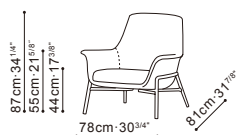

VOL. 0.65m³

	D	E	P	Q	R
Price (EURO)	1,015	1,065	1,115	1,280	1,465
Extra Cover (EURO)	200	250	300	465	650

Cushion
C08B0701.00

Extra Cover
B80B0701.00



	D	E	P	Q	R
Price (EURO)	65	75	90	110	125
Extra Cover (EURO)	40	50	65	85	100

OTTOMAN PUCK



- T stitch pattern
- Available in Fabric or Leather options. Fabric covers removable on Velcro
- Solid birch wood frame with MDF and plywood reinforcement, paired with cross-woven elastic webbing, covered with variable-density polyurethane foam and fabric lining
- Inset black plastic (ABS) legs giving the sofa a “floating” design

CHAIR PUCK

Ottoman
C0250302.00
 Extra Cover
B2050302.00

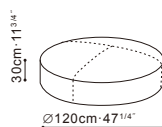

VOL. 0.5m³

	D	E	P	Q	R
Price (EURO)	615	650	750	970	1,125
Extra Cover (EURO)	165	200			

Ottoman
C0250303.00
 Extra Cover
B2050303.00

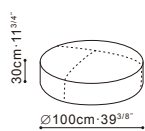

VOL. 0.35m³

	D	E	P	Q	R
Price (EURO)	525	565	665	775	890
Extra Cover (EURO)	150	190			

Ottoman
C0250304.00
 Extra Cover
B2050304.00

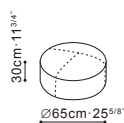

VOL. 0.2m³

	D	E	P	Q	R
Price (EURO)	360	375	400	460	500
Extra Cover (EURO)	90	105			

CHAIR PUZZLE



- Available in Fabric or Leather options. Covers not removable
- Solid birch wood seat and backrest frame with MDF and plywood reinforcement, paired with cross-woven elastic webbing, covered with modelling foam, high-resilient polyurethane foam and polyester fiber
- Solid ash wood armrest, available in grey oak finish
- Legs come with Teflon glides; an extra set of felt pads included in the packaging

CHAIR PUZZLE

Lounge Chair
C02F0401.07

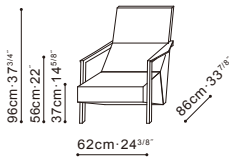

VOL. 0.6m³

CHAIR QING



- Available in Lounge Chair, Task Chair, and Ottoman
- Available in Fabric, Leather, or Fabric/Leather Combo options. Covers not removable
- Metal frame and plywood seat paired with cross-woven elastic webbing, covered with integrally-molded polyurethane foam
- Solid ash wood legs with Teflon glides for Chair C02D0701, C02D0703, and Ottoman C02D0705, available in grey oak finish; an extra set of felt pads included in the packaging
- 360° swivel steel bases for Chair C02D0702, C02D0704, C02D0707 and Ottoman C02D0706, available in glossy brown metallic paint finish with plastic glides
- A counterweight- equipped headrest for high backrest version filled with feather down, upholstery default in the same option as the inner side of the chair(Please refer to Page 6 for the details of different side)

CHAIR QING

Lounge Chair
C02D0701.07



VOL. 0.6m³

	D	E	P+D	P+E	Q+D	Q+E	R+D	R+E	P	Q	R
Price (EURO)	1,015	1,100	1,140	1,160	1,175	1,180	1,265	1,300	1,225	1,320	1,465

Swivel Lounge Chair
C02D0702.33



VOL. 0.6m³

	D	E	P+D	P+E	Q+D	Q+E	R+D	R+E	P	Q	R
Price (EURO)	1,100	1,175	1,215	1,240	1,250	1,285	1,340	1,375	1,300	1,395	1,540

Lounge Chair
C02D0703.07

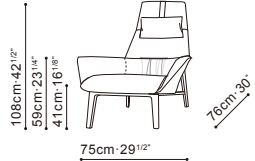

VOL. 0.65m³

	D	E	P+D	P+E	Q+D	Q+E	R+D	R+E	P	Q	R
Price (EURO)	1,140	1,215	1,250	1,265	1,300	1,310	1,375	1,415	1,340	1,430	1,575

Swivel Lounge Chair
C02D0704.33



VOL. 0.65m³

	D	E	P+D	P+E	Q+D	Q+E	R+D	R+E	P	Q	R
Price (EURO)	1,215	1,300	1,340	1,360	1,375	1,395	1,450	1,490	1,415	1,505	1,650

Ottoman
C02D0705.07



VOL. 0.15m³

	D	E	P	Q	R
Price (EURO)	440	465	490	500	515

Swivel Ottoman
C02D0706.33



VOL. 0.15m³

	D	E	P	Q	R
Price (EURO)	465	475	500	510	525

Swivel Task Chair
C02D0707.33

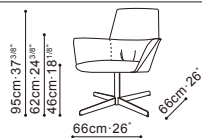

VOL. 0.65m³

	D	E	P+D	P+E	Q+D	Q+E	R+D	R+E	P	Q	R
Price (EURO)	1,175	1,250	1,300	1,320	1,340	1,350	1,415	1,450	1,375	1,470	1,615

CHAIR SOHO



- Available in Fabric or Leather options. Covers not removable
- Solid birch wood frame with plywood reinforcement, seat paired with cross-woven elastic webbing, covered with high-resilient polyurethane foam
- 360 ° swivel steel base in glossy brown metallic paint finish with plastic glides

CHAIR SOHO

Swivel Task Chair
C02G0302.33

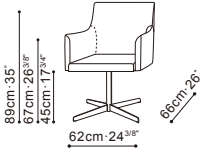

VOL. 0.5m³

	D	E	P	Q	R
Price (EURO)	900	975	1,100	1,205	1,275

CHAIR VAST



- Available in Fabric or Leather options. Covers not removable
- Solid birch wood seat and backrest frame with plywood reinforcement, covered with polyurethane foam and polyester fiber. Seat paired with cross-woven elastic webbing
- Solid ash wood armrest, available in grey oak or natural oak finish
- Legs come with Teflon glides

CHAIR VAST

Lounge Chair
C02B0601.

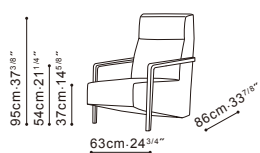

VOL. 0.6m³

	D	E	P	Q	R
Grey Oak C02B0601.07	965	1,000	1,140	1,240	1,425
Natural Oak C02B0601.08	965	1,000	1,140	1,240	1,425

CHAIR VENUS

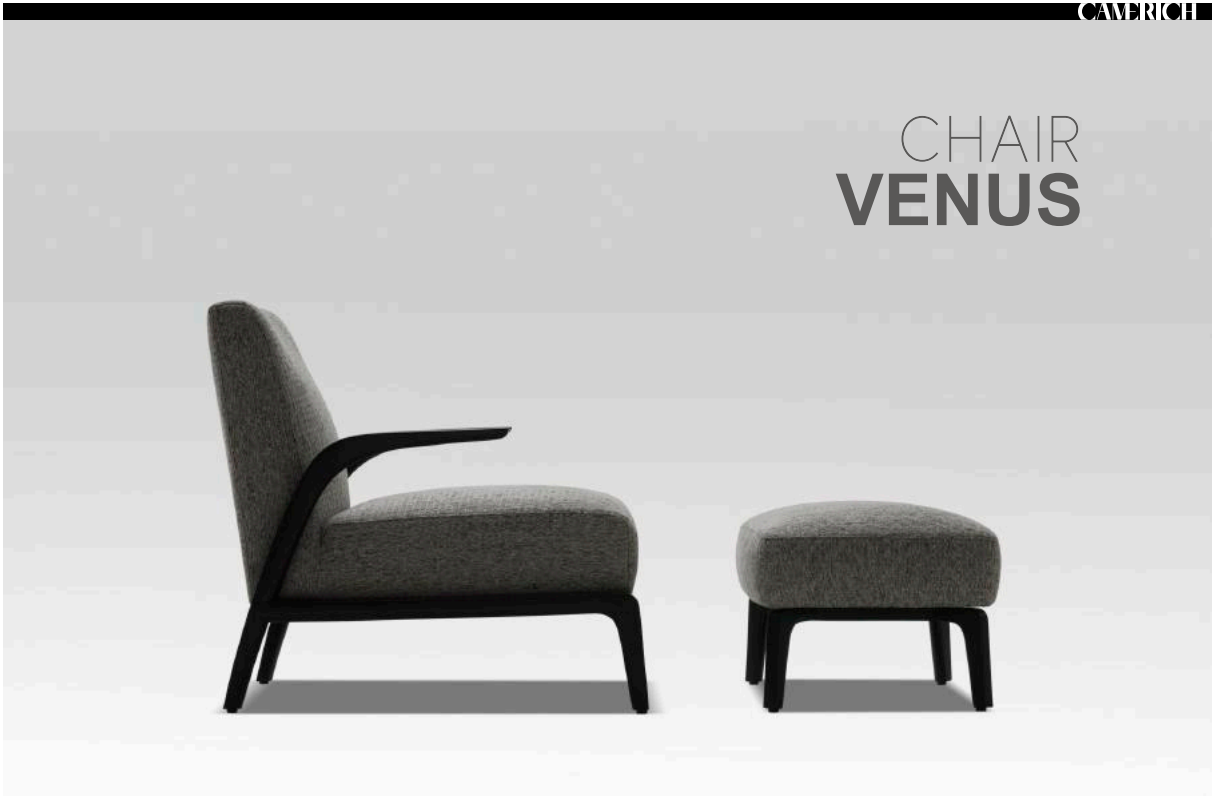

- Available in Fabric or Leather options. Covers not removable
- Solid birch wood seat and backrest frame with plywood reinforcement, paired with cross-wove elastic webbing ,covered with polyurethane foam and polyester fiber
- Solid ash wood armrest, available in grey oak or natural oak finish
- Legs come with Teflon glides; an extra set of felt pads included in the packaging

CHAIR VENUS

Lounge Chair
C02A1701.

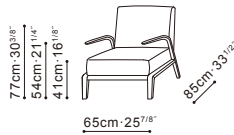

VOL. 0.5m³

	D	E	F	P	Q	R
Grey Oak C02A1701.07	915	965	1,080	1,060	1,100	1,150
Natural Oak C02A1701.08	915	965	1,080	1,060	1,100	1,150

Ottoman
C02A1702.



VOL. 0.15m³

	D	E	F	P	Q	R
Grey Oak C02A1702.07	375	415	465	465	470	525
Natural Oak C02A1702.08	375	415	465	465	470	525

CHAIR WALTZ PLUS



- Available in Fabric or Leather options. Covers removable on zipper
- Compression-molded steel seat and backrest frame, covered with integrally-molded polyurethane foam and fabric lining
- Black metallic painted steel frame comes with plastic glides

CHAIR WALTZ PLUS

Dining Chair
C02A0100.3A
 Extra Cover
B20A0100.00

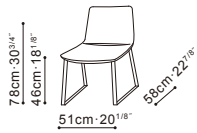

VOL. 0.2m³

	D	E	P	Q	R
Price (EURO)	550	590	600	640	675
Extra Cover (EURO)	115	155	165	205	240

CHAIR WING



- Available in Armless, Arm Dining Chair and Lounge Chair
- Available in Fabric or Leather options. Covers not removable
- Anti-rusted metal backrest, plywood seat frame paired with cross-woven elastic webbing, covered with polyurethane foam and polyester fiber
- Solid ash wood leg with Teflon glides in grey oak finish for C02H0401 and C02H0402, connected to the seat by black metallic painted steel bracket; an extra set of felt pads included in the packaging
- Black or gold metallic painted steel leg with Teflon glides for C02H0403 and C02H0404
- Solid ash wood leg with plastic glides in grey oak finish for C02H0405, connected to the seat by black powder coated steel rotation shaft

CHAIR WING

Dining Chair
C02H0401.07



VOL. 0.35m³

	D	E	F	P	Q	R
Price (EURO)	775	805	925	875	945	1,050

Dining Chair
C02H0402.07

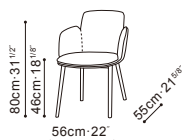

VOL. 0.35m³

	D	E	F	P	Q	R
Price (EURO)	850	875	1,000	950	1,050	1,165

Dining Chair
C02H0403.



VOL. 0.35m³

	D	E	F	P	Q	R
Black Steel C02H0403.3A	875	910	1,015	980	1,050	1,155
Gold Steel C02H0403.32	945	980	1,100	1,050	1,120	1,225

Dining Chair
C02H0404.



VOL. 0.35m³

	D	E	F	P	Q	R
Black Steel C02H0404.3A	945	980	1,100	1,050	1,155	1,260
Gold Steel C02H0404.32	1,015	1,050	1,170	1,120	1,225	1,330

Swivel Lounge Chair
C02H0405.07

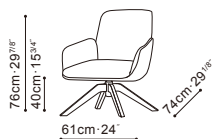

VOL. 0.4m³

	D	E	F	P	Q	R
Price (EURO)	1,430	1,510	1,570	1,560	1,600	1,750

BEDS

AMOR	140
ALISON BED PLUS	142
CRESCENT	146
EDEN	150
ELAN	152
EMBRACE	156
LUNA	158
MELODY	162
NATURE	166
STRATUS	170

BED AMOR



- Features unique “double folded” tight back design
- Available in Fabric or Leather options. Covers removable on Velcro
- Solid birch wood headboard with plywood and MDF reinforcement, plywood side and end rails, covered with integrally-molded polyurethane foam and fabric lining
- Steel-framed beech wood slat with narrow rib gaps is friendly to the pocket spring mattress
- Steel legs in black metallic paint with plastic glides

N.B.: Recommended mattress thickness less than 30cm
Price doesn't include mattress

BED AMOR

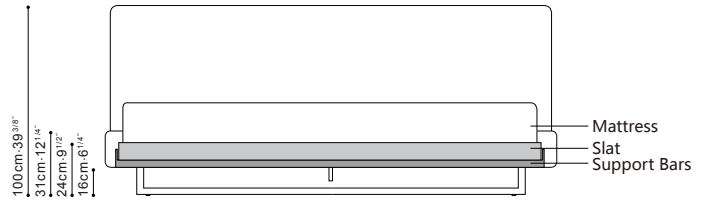

C03J0301.3A Extra Cover B30J0301.00

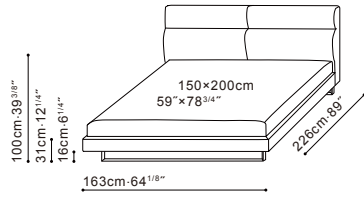

VOL. 1.0m³

	D	E	Q	R
Price (EURO)	2,150	2,315	2,555	2,985
Extra Cover (EURO)	440	605		

C03J0302.3A Extra Cover B30J0302.00

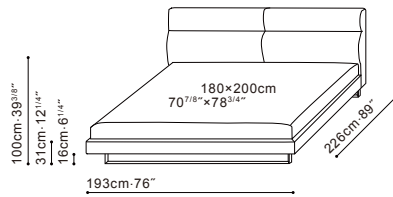

VOL. 1.1m³

	D	E	Q	R
Price (EURO)	2,275	2,440	2,735	3,165
Extra Cover (EURO)	475	640		

C03J0304.3A Extra Cover B30J0304.00

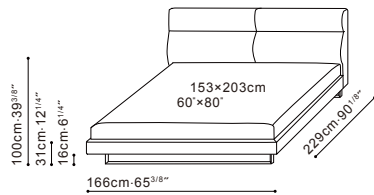

VOL. 1.0m³

	D	E	Q	R
Price (EURO)	2,240	2,390	2,655	3,085
Extra Cover (EURO)	465	615		

C03J0305.3A Extra Cover B30J0305.00

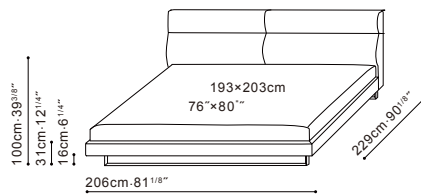

VOL. 1.2m³

	D	E	Q	R
Price (EURO)	2,350	2,515	2,835	3,265
Extra Cover (EURO)	500	665		

BED ALISON BED PLUS



- Available in fabric or Leather options. Covers removable on Velcro
- Solid birch wood headboard with plywood reinforcement, plywood side and end rails, all covered with polyurethane foam and fabric lining
- Multiply beech wood slat system with slight firmness adjustment
- Alloyed die-casted legs in black metallic paint with plastic glides

N.B. • Recommended mattress thickness less than 25cm

- Price doesn't include mattress

BED ALISON BED PLUS

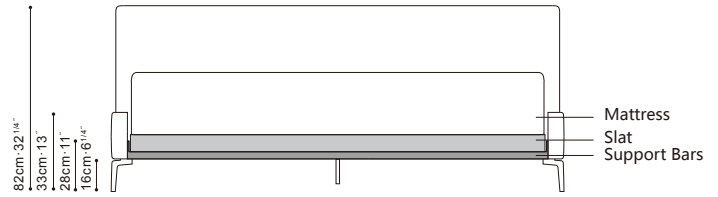

C03J0201.3A

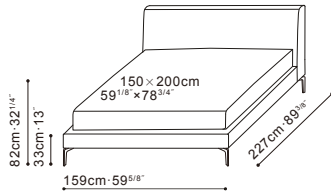

VOL. 1.1m³

	D	E	Q	R
Price (EURO)	1,840	1,990	2,230	2,445
Extra Cover (EURO)	375	525	765	980

C03J0202.3A

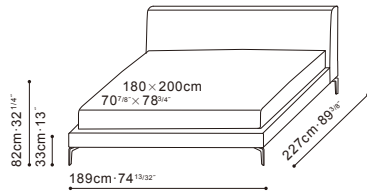

VOL. 1.2m³

	D	E	Q	R
Price (EURO)	1,950	2,115	2,410	2,625
Extra Cover (EURO)	415	580	875	1,090

C03J0204.3A

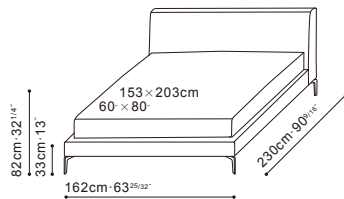

VOL. 1.1m³

	D	E	Q	R
Price (EURO)	1,915	2,075	2,330	2,545
Extra Cover (EURO)	400	580	815	1,030

C03J0205.3A

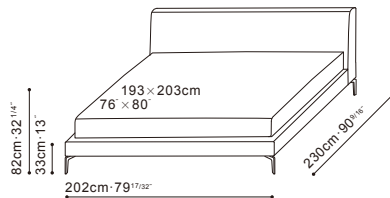

VOL. 1.3m³

	D	E	Q	R
Price (EURO)	2,040	2,190	2,510	2,725
Extra Cover (EURO)	440	600	920	1,140

Bench
C03J0233.3A
 Extra Cover
B30J0233.

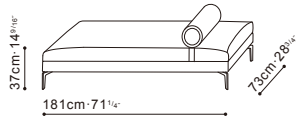

VOL. 0.45m³

	D	E	Q	R
Price (EURO)	1,065	1,150	1,470	1,725
Extra Cover (EURO)	265	350		

Bench
C03J0232.3A
 Extra Cover
B30J0232.

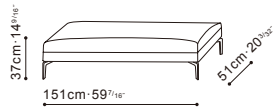

VOL. 0.3m³

	D	E	Q	R
Price (EURO)	800	840	970	1,115
Extra Cover (EURO)	240	280		

BED CRESCENT BED



- Available in Fabric or Leather options. Covers removable on Velcro
- Solid birch wood headboard with plywood reinforcement, plywood side and end rails, all covered with polyurethane foam and fabric lining
- Steel-framed beech wood slat with narrow rib gaps is friendly to the pocket spring mattress
- Alloyed die-casted base in black metallic paint with plastic glides

N.B. • Recommended mattress thickness less than 35cm

- Price doesn't include mattress

BED CRESCENT BED

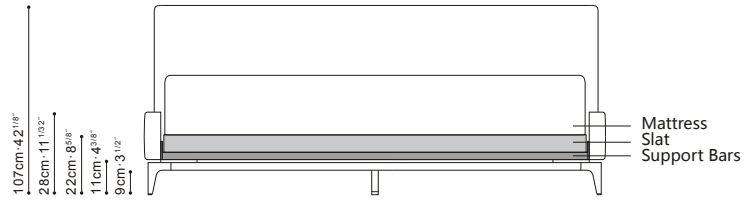

C03J0401.3A

Extra Cover
B30J0401.

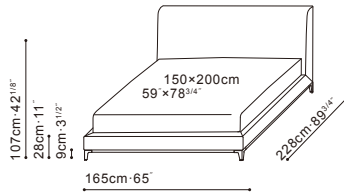

VOL. 0.8m³

	D	E	Q	R
Price (EURO)	2,275	2,440	2,620	3,050
Extra Cover (EURO)	475	640	820	1,250

C03J0402.3A

Extra Cover
B30J0402.

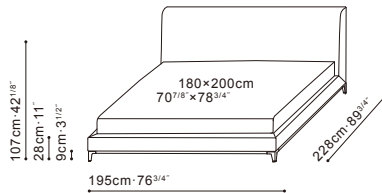

VOL. 0.9m³

	D	E	Q	R
Price (EURO)	2,390	2,550	2,800	3,230
Extra Cover (EURO)	515	675	925	1,355

C03J0403.3A

Extra Cover
B30J0403.

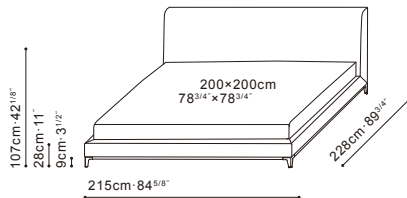

VOL. 1.0m³

	D	E	Q	R
Price (EURO)	2,515	2,675	2,980	3,410
Extra Cover (EURO)	565	725	1,030	1,460

C03J0404.3A.

Extra Cover
B30J0404.

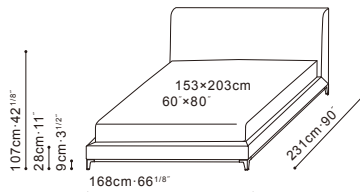

VOL. 0.85m³

	D	E	Q	R
Price (EURO)	2,350	2,515	2,735	3,165
Extra Cover (EURO)	500	665	885	1,315

C03J0405.3A.

Extra Cover
B30J0405.

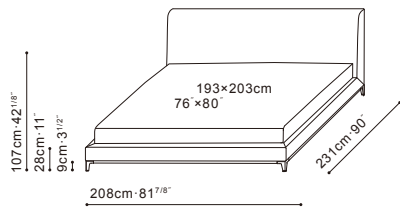

VOL. 0.95m³

	D	E	Q	R
Price (EURO)	2,475	2,640	2,915	3,345
Extra Cover (EURO)	540	705	980	1,410

Daybed

C03J0431.3A

Extra Cover
B30J0431.

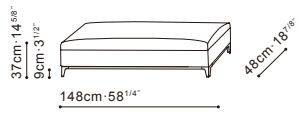

VOL. 0.3m³

	D	E	Q	R
Price (EURO)	965	1,065	1,250	1,395
Extra Cover (EURO)	240	340		

BED EDEN



- Available in Fabric, Leather or Fabric/Leather Combo options. Covers removable on Velcro
- Solid birch wood headboard with plywood and MDF reinforcement, plywood side and end rails, all covered with polyurethane foam and fabric lining
- Beech wood slat in metal frame with gas cylinder support system, opening vertically
- Melamine base board creates storage compartments underneath
- Black plastic (ABS) legs

N.B.: Recommended mattress thickness less than 25cm, mattress maximum weight 65KG
Price doesn't include mattress



BED EDEN

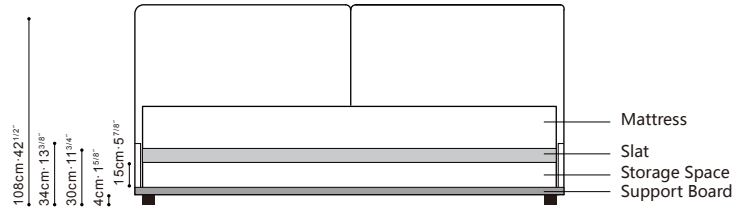

C03G0501.00

Extra Cover
B30G0501.00

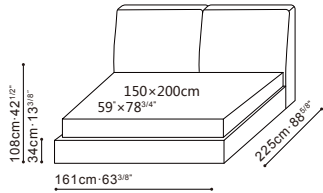

VOL. 1.3m³

	D	E	Q+D	Q+E	R+D	R+E	Q	R
Price (EURO)	3,865	4,065	4,000	4,100	4,250	4,365	4,200	4,410
Extra Cover (EURO)	515	715	650	750	900	1,015	850	1,060

C03G0502.00

Extra Cover
B30G0502.00

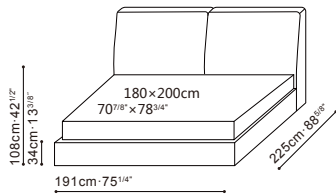

VOL. 1.45m³

	D	E	Q+D	Q+E	R+D	R+E	Q	R
Price (EURO)	3,990	4,190	4,100	4,200	4,400	4,515	4,300	4,580
Extra Cover (EURO)	565	765	675	775	975	1,090	875	1,155

C03G0504.00

Extra Cover
B30G0504.00

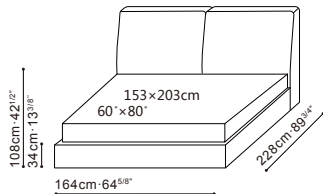

VOL. 1.35m³

	D	E	Q+D	Q+E	R+D	R+E	Q	R
Price (EURO)	3,950	4,150	4,090	4,190	4,325	4,440	4,280	4,515
Extra Cover (EURO)	530	730	670	770	905	1,020	860	1,095

C03G0505.00

Extra Cover
B30G0505.00

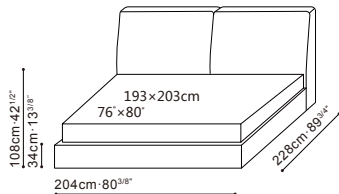

VOL. 1.55m³

	D	E	Q+D	Q+E	R+D	R+E	Q	R
Price (EURO)	4,065	4,245	4,150	4,250	4,475	4,600	4,350	4,680
Extra Cover (EURO)	595	775	680	780	1,005	1,130	880	1,210

BED ELAN



- Derived from the Elan Sofa series
- Available in Fabric or Leather options. Covers removable on Velcro
- Steel headboard reinforced by solid birch wood, plywood and MDF, plywood side and end rails, all covered with polyurethane foam, polyester fiber and fabric lining
- Steel-framed beech wood slat with narrow rib gaps is friendly to the pocket spring mattress
- Steel legs in black metallic paint with plastic glides

N.B.: Recommended mattress thickness less than 30cm
Price doesn't include mattress

BED ELAN

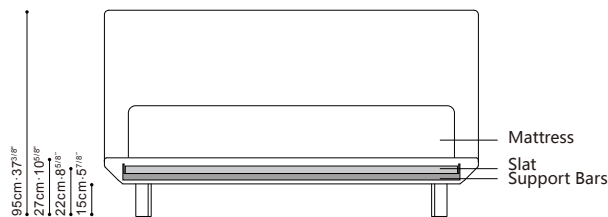

C03D0501.3A

Extra Cover
B30D0501.00

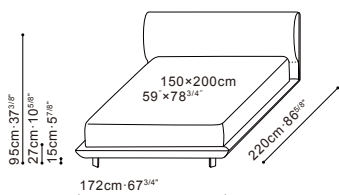

VOL. 1.05m³

	D	E	Q	R
Price (EURO)	1,750	1,900	2,070	2,275
Extra Cover (EURO)	365	515	685	890

C03D0502.3A

Extra Cover
B30D0502.00

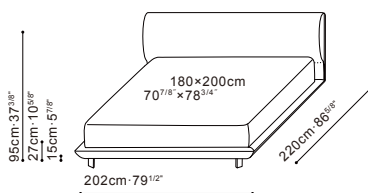

VOL. 1.1m³

	D	E	Q	R
Price (EURO)	1,875	2,015	2,240	2,445
Extra Cover (EURO)	400	540	765	970

C03D0503.3A

Extra Cover
B30D0503.00

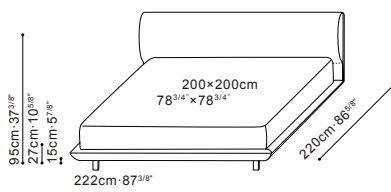

VOL. 1.2m³

	D	E	Q	R
Price (EURO)	1,990	2,140	2,405	2,610
Extra Cover (EURO)	440	590	855	1,060

C03D0504.3A

Extra Cover
B30D0504.00

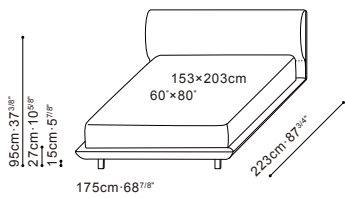

VOL. 0.95m³

	D	E	Q	R
Price (EURO)	1,840	1,985	2,170	2,375
Extra Cover (EURO)	375	520	705	910

ELAN

C03D0505.3A

Extra Cover

B30D0505.00

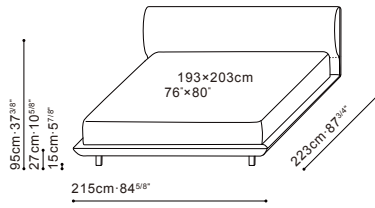

VOL. 1.15m³

	D	E	Q	R
Price (EURO)	1,950	2,090	2,340	2,545
Extra Cover (EURO)	415	555	805	1,010

BED EMBRACE



- Derived from the Embrace chair series
- Available in Fabric or Leather options. Covers not removable
- Plywood headboard with internal steel frame and MDF reinforcement, covered with polyurethane foam and polyester fiber
- Plywood side and end rails, covered with polyurethane foam and fabric lining
- Steel-framed beech wood slat with narrow rib gaps is friendly to the pocket spring mattress
- Steel legs in black metallic paint with plastic glides

N.B.: Recommended mattress thickness less than 30cm

Price does not include mattress

BED EMBRACE

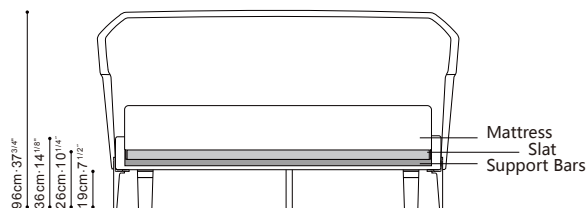

C03E0101.3A

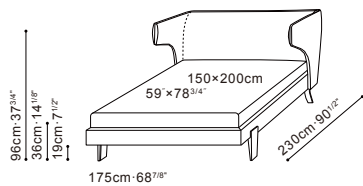

VOL. 1.0m³

	D	E	Q	R
Price (EURO)	2,315	2,475	2,650	3,080

C03E0102.3A

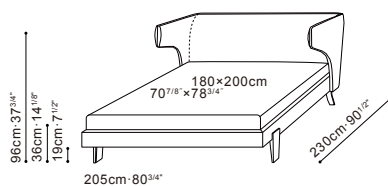

VOL. 1.1m³

	D	E	Q	R
Price (EURO)	2,440	2,590	2,825	3,255

C03E0103.3A

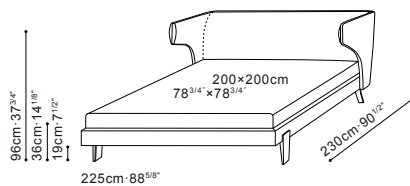

VOL. 1.2m³

	D	E	Q	R
Price (EURO)	2,550	2,715	3,005	3,435

C03E0104.3A

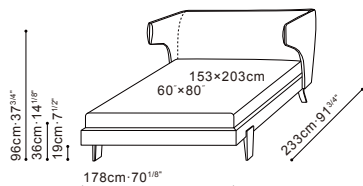

VOL. 1.1m³

	D	E	Q	R
Price (EURO)	2,390	2,550	2,755	3,185

C03E0105.3A

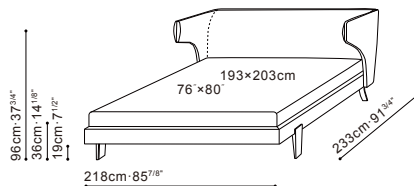

VOL. 1.15m³

	D	E	Q	R
Price (EURO)	2,515	2,675	2,935	3,365

BED LUNA



- Available in Fabric or Leather options. Covers removable on Velcro
- Solid birch wood headboard with plywood and MDF reinforcement, plywood side and end rails, all covered with polyurethane foam and fabric lining
- Steel-framed beech wood slat with narrow rib gaps is friendly to the pocket spring mattress
- Steel legs in grey metallic paint with plastic glides

N.B.: Recommended mattress thickness less than 40cm
Price doesn't include mattress

BED LUNA

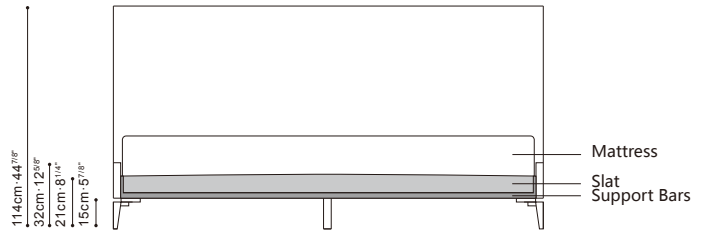

C03F0611.34

Extra Cover
B30F0611.00

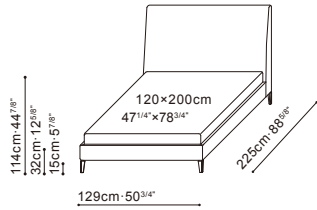

VOL. 0.7m³

	D	E	Q	R
Price (EURO)	1,875	2,040	2,140	2,375
Extra Cover (EURO)	365	530	630	865

C03F0601.34

Extra Cover
B30F0601.00

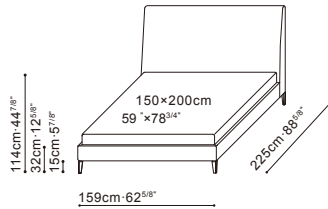

VOL. 0.85m³

	D	E	Q	R
Price (EURO)	1,950	2,115	2,275	2,510
Extra Cover (EURO)	375	540	700	935

C03F0602.34

Extra Cover
B30F0602.00

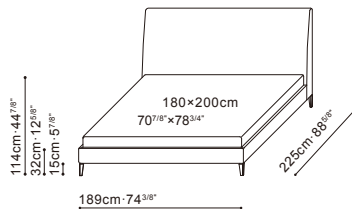

VOL. 0.95m³

	D	E	Q	R
Price (EURO)	2,075	2,240	2,445	2,680
Extra Cover (EURO)	415	580	785	1,020

C03F0603.34

Extra Cover
B30F0603.00

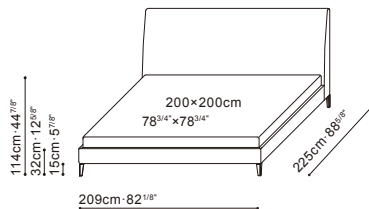

VOL. 1.05m³

	D	E	Q	R
Price (EURO)	2,190	2,350	2,615	2,850
Extra Cover (EURO)	465	625	890	1,125

LUNA

C03F0612.34

Extra Cover

B30F0612.00

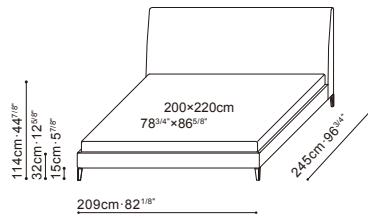

VOL. 1.2m³

	D	E	Q	R
Price (EURO)	2,390	2,550	2,885	3,120
Extra Cover (EURO)	500	660	995	1,230

C03F0604.34

Extra Cover

B30F0604.00

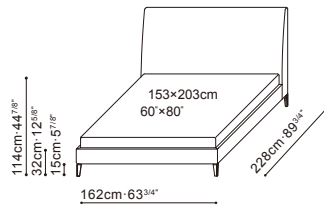

VOL. 0.85m³

	D	E	Q	R
Price (EURO)	2,040	2,190	2,375	2,610
Extra Cover (EURO)	400	550	735	970

C03F0605.34

Extra Cover

B30F0605.00

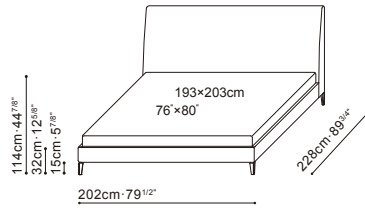

VOL. 1.0m³

	D	E	Q	R
Price (EURO)	2,150	2,315	2,545	2,780
Extra Cover (EURO)	440	605	835	1,070

BED MELODY



- Available in Fabric, Leather or Fabric/Leather Combo options. Headboard covers not removable
- Metal headboard with MDF and plywood reinforcement, covered with polyurethane foam
- Plywood side and end rails covered with polyurethane foam and fabric lining
- Steel-framed beech wood slat with narrow rib gaps is friendly to the pocket spring mattress
- Throw cushions consist of feather down and polyester fiber padding with polyurethane foam center insert
- Bolsters filled with polyurethane foam
- Steel legs in glossy grey metallic paint with plastic glides

N.B. Recommended mattress thickness less than 25cm

Price doesn't include mattress

BED MELODY

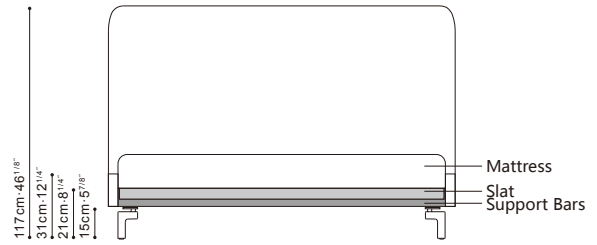

C03H0701.34

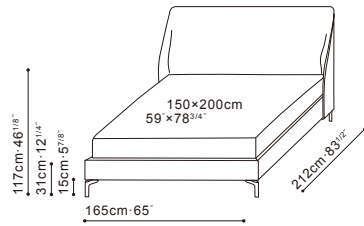

VOL. 0.85m³

	D	E	P+D	P+E	Q+D	Q+E	R+D	R+E	Q	R
Price (EURO)	2,450	2,615	2,590	2,690	2,700	2,810	3,175	3,290	2,905	3,340

C03H0702.34

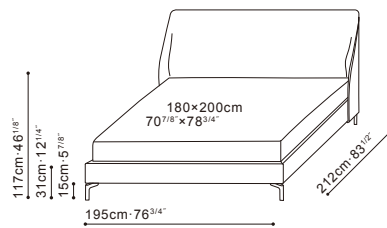

VOL. 0.95m³

	D	E	P+D	P+E	Q+D	Q+E	R+D	R+E	Q	R
Price (EURO)	2,650	2,815	2,780	2,880	2,915	3,040	3,400	3,515	3,155	3,590

C03H0704.34

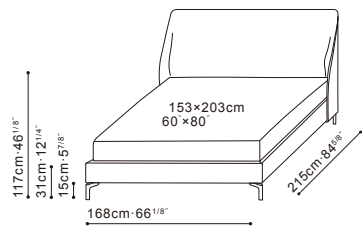

VOL. 0.85m³

	D	E	P+D	P+E	Q+D	Q+E	R+D	R+E	Q	R
Price (EURO)	2,575	2,740	2,700	2,810	2,850	2,965	3,325	3,440	3,090	3,525

C03H0705.34

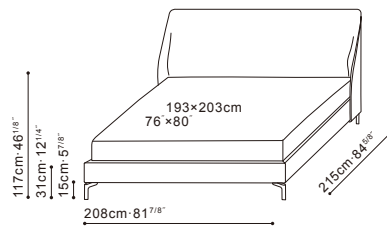

VOL. 1.05m³

	D	E	P+D	P+E	Q+D	Q+E	R+D	R+E	Q	R
Price (EURO)	2,775	2,925	2,890	3,000	3,070	3,190	3,550	3,665	3,340	3,775

MELODY

Cushion

C08H0701.00

Extra Cover

B80H0701.00

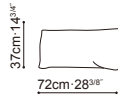

Optional cushion for C03H0702,C03H0705

	D	E	Q	R
Price (EURO)	75	90	145	175
Extra Cover (EURO)	50	65	125	150

Cushion

C08H0702.00

Extra Cover

B80H0702.00

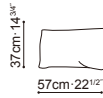

Optional cushion for C03H0701,C03H0704

	D	E	Q	R
Price (EURO)	65	75	110	140
Extra Cover (EURO)	40	50	85	115

Bolster

C08H0703.00

Extra Cover

B80H0703.00

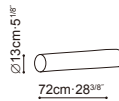

Optional bolster for C03H0702,C03H0705

	D	E	Q	R
Price (EURO)	75	90	145	175
Extra Cover (EURO)	50	65	120	150

Bolster

C08H0704.00

Extra Cover

B80H0704.00



Optional bolster for C03H0701,C03H0704

	D	E	Q	R
Price (EURO)	65	75	110	140
Extra Cover (EURO)	40	50	85	115

BED NATURE



- Available in Fabric or Leather options. Covers removable on Velcro (headboard needs to be unscrewed in order for covers to be removed)
- Plywood headboard with MDF reinforcement, wrapped in feather down
- Plywood side and end rails, covered with polyurethane foam and fabric lining
- Steel-framed beech wood slat with narrow rib gaps is friendly to the pocket spring mattress
- Black anodized aluminium legs with plastic glides, height slightly adjustable for uneven floors

N.B.: Recommended mattress thickness less than 25cm

Price doesn't include mattress

BED NATURE

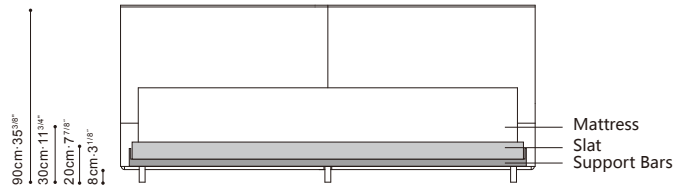

C03E0701.31
Extra Cover
B30E0701.00

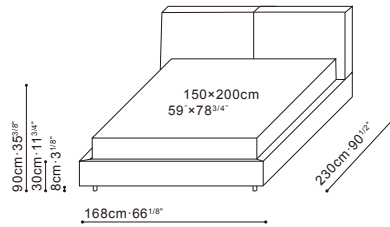

VOL. 0.9m³

	D	E	Q	R
Price (EURO)	2,075	2,240	2,375	2,780
Extra Cover (EURO)	400	565	700	1,105

C03E0702.31
Extra Cover
B30E0702.00

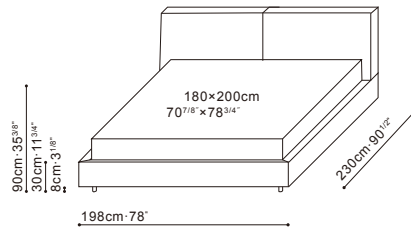

VOL. 1.0m³

	D	E	Q	R
Price (EURO)	2,190	2,350	2,545	2,950
Extra Cover (EURO)	440	600	795	1,200

C03E0703.31
Extra Cover
B30E0703.00

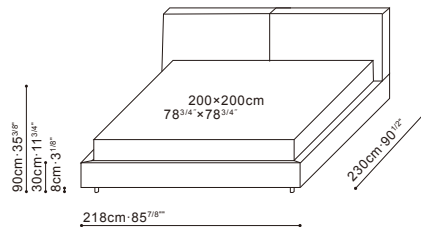

VOL. 1.1m³

	D	E	Q	R
Price (EURO)	2,315	2,475	2,715	3,120
Extra Cover (EURO)	475	635	875	1,280

C03E0712.31
Extra Cover
B30E0712.00

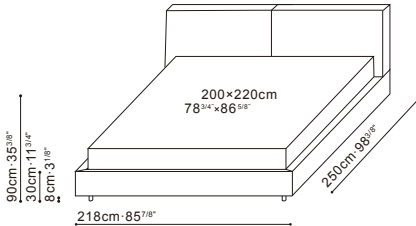

VOL. 1.3m³

	D	E	Q	R
Price (EURO)	2,475	2,635	2,915	3,320
Extra Cover (EURO)	505	665	945	1,350

NATURE

C03E0704.31

Extra Cover

B30E0704.00

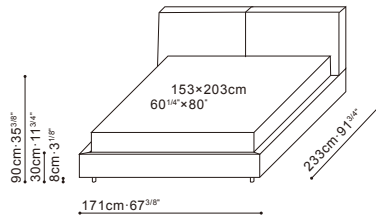

VOL. 0.9m³

	D	E	Q	R
Price (EURO)	2,150	2,315	2,475	2,880
Extra Cover (EURO)	415	580	740	1,145

C03E0705.31

Extra Cover

B30E0705.00

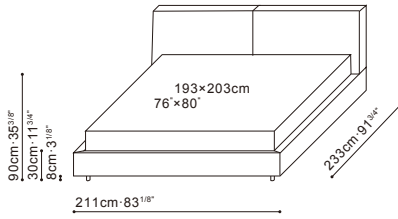

VOL. 1.05m³

	D	E	Q	R
Price (EURO)	2,275	2,440	2,645	3,050
Extra Cover (EURO)	465	630	835	1,240

BED STRATUS



- High headboard design with stitches details, providing with or without screen & drawers options to fit in different spaces
- Available in Leather, or Fabric/Leather Combo options (Please see Specs for details). Head board covers not removable
- Solid birch wood headboard, reinforced by MDF and plywood, covered with polyurethane foam
- Steel front rail, plywood side and end rails, covered with polyurethane foam and fabric lining
- Steel-framed beech wood slat with narrow rib gaps is friendly to the pocket spring mattress
- Steel legs in black metallic paint with plastic glides

Drawer

- Graphite oak or natural oak veneered top
- Soft-close flap lid with dustproof brush to shield the hidden cord management
- Drawer in Dove lacquer comes with full extension invisible drawer runners with dampers

N.B. Recommended mattress thickness less than 30cm

Price doesn't include mattress

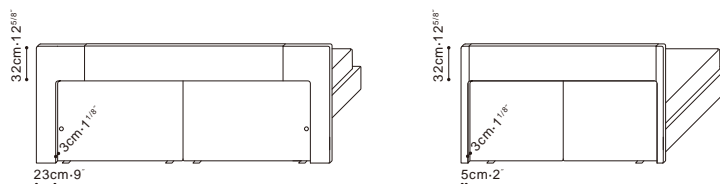

BED STRATUS

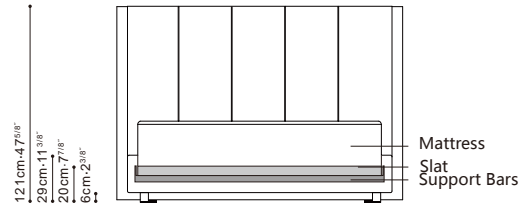

C03J0102.00

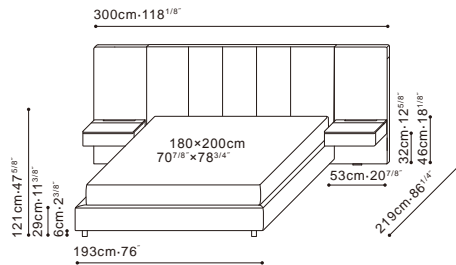

VOL.1.1m³

Price doesn't include B32J0101.

	P+D	P+E	Q+D	Q+E	R+D	R+E
Price (EURO)	3,960	4,140	4,320	4,500	4,860	5,040

C03J0103.00

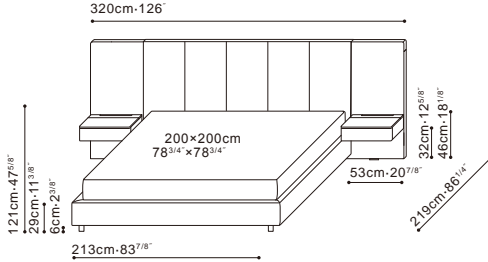

VOL.1.15m³

Price doesn't include B32J0101.

	P+D	P+E	Q+D	Q+E	R+D	R+E
Price (EURO)	4,320	4,500	4,680	4,860	5,220	5,400

C03J0112.00

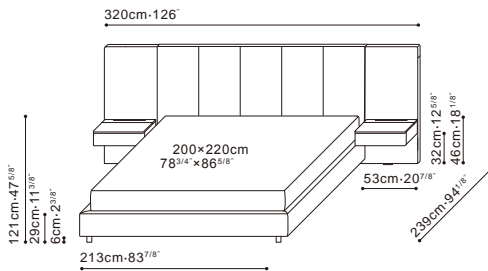

VOL.1.2m³

Price doesn't include B32J0101.

	P+D	P+E	Q+D	Q+E	R+D	R+E
Price (EURO)	4,500	4,680	4,860	5,040	5,400	5,580

STRATUS

C03J0105.00

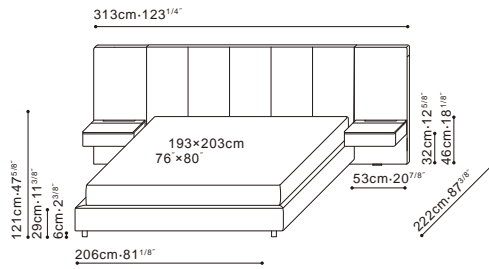

VOL.1.15m³

Price doesn't include B32J0101.

	P+D	P+E	Q+D	Q+E	R+D	R+E
Price (EURO)	4,140	4,320	4,500	4,680	5,040	5,220

C03J0121.00

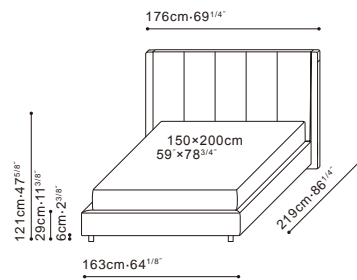

VOL.0.85m³

	P+D	P+E	Q+D	Q+E	R+D	R+E	Q	R
Price (EURO)	2,810	2,990	3,060	3,240	3,420	3,600	3,760	4,280

C03J0122.00

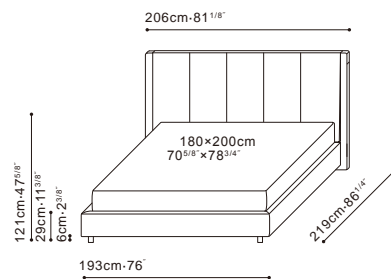

VOL.0.95m³

	P+D	P+E	Q+D	Q+E	R+D	R+E	Q	R
Price (EURO)	3,030	3,210	3,310	3,490	3,670	3,850	4,100	4,620

C03J0123.00

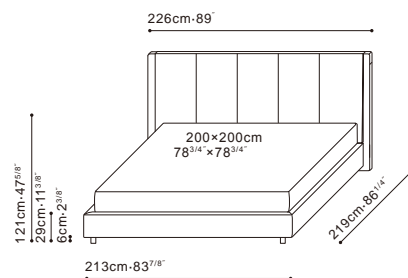

VOL.1.0m³

	P+D	P+E	Q+D	Q+E	R+D	R+E	Q	R
Price (EURO)	3,240	3,420	3,600	3,780	3,960	4,140	4,440	4,960

C03J0132.00

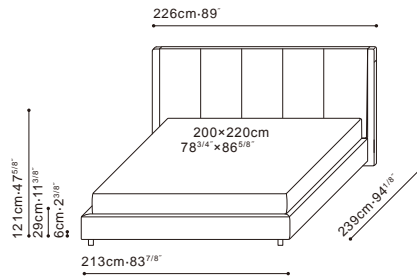

VOL.1.05m³

	P+D	P+E	Q+D	Q+E	R+D	R+E	Q	R
Price (EURO)	3,420	3,600	3,780	3,960	4,140	4,320	4,610	5,130

C03J0124.00

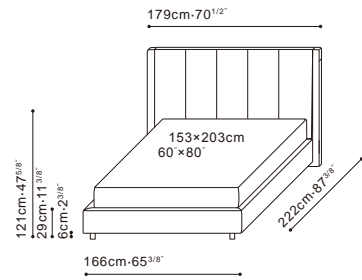

VOL.0.85m³

	P+D	P+E	Q+D	Q+E	R+D	R+E	Q	R
Price (EURO)	2,950	3,130	3,210	3,380	3,570	3,750	3,930	4,450

C03J0125.00

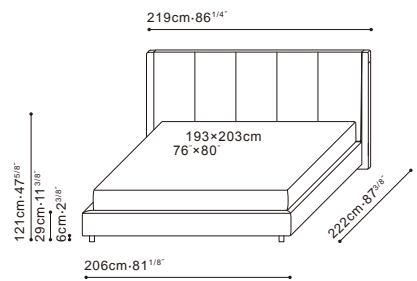

VOL.1.0m³

	P+D	P+E	Q+D	Q+E	R+D	R+E	Q	R
Price (EURO)	3,170	3,350	3,460	3,640	3,820	4,000	4,270	4,790

Drawer Cabinet
B32J0101.00

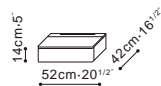

Graphite Oak+Dove

B32J0101.00.0000

470

Natural Oak+Dove

B32J0101.00.0001

440

VOL.0.1m³

COFFEE TABLES

BLEND	176
CLEO	178
DRUM	180
ELEMENT	182
ENZO	184
FLAMINGO	186
HANNA	188
HARMON	190
JOY	192
PEBBLE	194
RUBIX	196
SLICE	198
SPIN	200
TERI	202
VARY	204

COFFEE TABLE BLEND



Coffee Table

- Available in grey oak veneer
- White ceramic top for C06G0401 and C06G0406
- Built-in drawer structure in grey oak melamine, comes with full extension invisible drawer runners with dampers
- Plastic glides installed at the bottom

Ottoman

- Available in Fabric or Leather options. Fabric covers removable on Velcro
- Plywood frame with MDF reinforcement, seat paired with cross-woven elastic webbing, covered in polyurethane foam and fabric lining
- Four castors affixed at the bottom

COFFEE TABLE BLEND

Coffee Table
C06G0401.

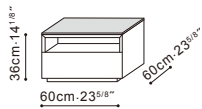

White Ceramic + Grey Oak
C06G0401.00.0000

925

VOL. 0.2m³

Coffee Table
C06G0404.

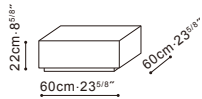

Grey Oak
C06G0404.00.0000

425

VOL. 0.15m³

Coffee Table
C06G0406.

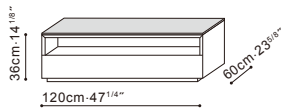

White Ceramic + Grey Oak
C06G0406.00.0000

1,545

VOL. 0.4m³

Ottoman
C02G0403.00
Extra Cover
B20G0403.00

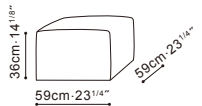

VOL. 0.2m³

	D	E	F	P	Q	R
Price (EURO)	375	390	510	490	575	650
Extra Cover (EURO)	85	100	220			

SIDE TABLE CLEO



- Top available in Carrara marble, Galaxy Grey marble, or grey oak veneer
- Black metallic painted steel frame comes with a storage bag in Eco Leather FC series
- Plastic glides installed at the bottom

SIDE TABLE CLEO

Side Table
C06G0601.

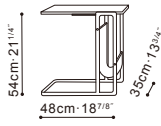

Grey Oak + FC-08

C06G0601.3A.0000

490

Grey Oak + FC-11

C06G0601.3A.0001

Carrara Marble + FC-08

C06G0601.3A.0002

725

Carrara Marble + FC-11

C06G0601.3A.0003

Galaxy Grey Marble + FC-08

C06G0601.3A.0004

725

Galaxy Grey Marble + FC-11

C06G0601.3A.0005

VOL. 0.2m³

OTTOMAN DRUM



C06A1101 and C06A1102

- Black walnut veneered top
- Solid birch wood frame with plywood reinforcement, covered with polyurethane foam, upholstered in P, Q or R grade leather
- C06A1101 version comes with five castors and the top is removable for storage
- Plastic glides installed at the bottom of C06A1102

C02A1103 Ottoman

- Available in Fabric or Leather options. Covers not removable
- Solid birch wood frame with MDF and plywood reinforcement, covered in modelling foam and polyester fiber
- Black plastic (ABS) legs with glides

OTTOMAN DRUM

Ottoman
C06A1101.

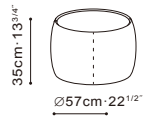

Black Walnut + P
C06A1101.09 490

Black Walnut + Q
C06A1101.09 545

Black Walnut + R
C06A1101.09 625

VOL. 0.15m³

Ottoman
C06A1102.

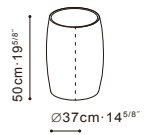

Black Walnut + P
C06A1102.09 390

Black Walnut + Q
C06A1102.09 445

Black Walnut + R
C06A1102.09 490

VOL. 0.1m³

Ottoman
C02A1103.00

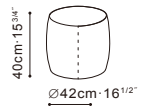

VOL. 0.1m³

	D	E	F	P	Q	R
Price (EURO)	315	345	385	370	415	480

COFFEE TABLE ELEMENT



- Carrara Marble or Galaxy Grey Marble top
- Grey oak veneered base board, with the exception to C0600046
- Steel frame in black metallic paint

COFFEE TABLE ELEMENT

Coffee Table
C0600045.

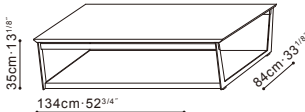

Carrara Marble
C0600045.3A.0000

----- 1,875

Galaxy Grey Marble
C0600045.3A.0001

VOL. 0.7m³

COFFEE TABLE **ENZO**



- Black walnut veneered top with solid walnut wood edges
- Steel base in black metallic paint with plastic glides
- C06A1202 version includes a built-in drawer

COFFEE TABLE ENZO

Side Table
C06A1202.

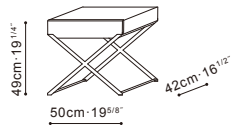

Black Walnut
C06A1202.3A.0000

690

VOL. 0.2m³

Coffee Table
C06A1203.

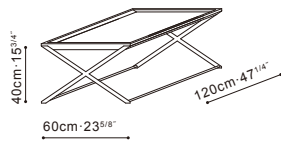

Black Walnut
C06A1203.3A.0000

925

VOL. 0.35m³

Console
C06A1204.

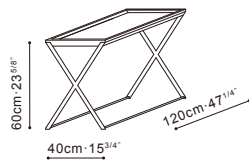

Black Walnut
C06A1204.3A.0000

840

VOL. 0.35m³

COFFEE TABLE FLAMINGO



- Oak veneered top and drawer front
- Built-in drawer structure in melamine, comes with full extension invisible drawer runners with dampers
- Available in grey oak, natural oak, or graphite oak finish
- Steel frame in black metallic paint or CHP silver metallic paint with plastic glides

COFFEE TABLE FLAMINGO

Coffee Table
C06C0901.

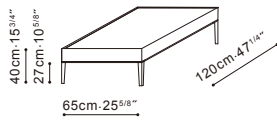

Grey Oak

C06C0901.3A.0000

990

Natural Oak

C06C0901.35.0003

Graphite Oak

C06C0901.3A.0001

1,280

VOL. 0.3m³

Coffee Table
C06C0902.

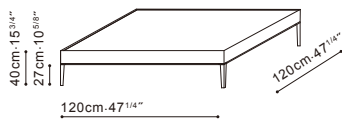

Grey Oak

C06C0902.3A.0000

1,350

Natural Oak

C06C0902.35.0003

Graphite Oak

C06C0902.3A.0001

1,775

VOL. 0.45m³

COFFEE TABLE **HANNA**



- Carrara marble top
- White powder coated steel base with plastic glides

COFFEE TABLE HANNA

Side Table

C0600036.

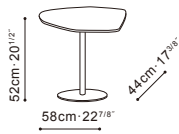

**Carrara Marble
+ White Steel**
C0600036.30.0000

640

VOL. 0.3m³

Coffee Table

C0600037.

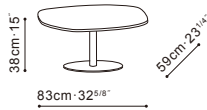

**Carrara Marble
+ White Steel**
C0600037.30.0000

925

VOL. 0.3m³

SIDE TABLE HARMON



C06B0502 Side Table

- Top available in Carrara marble or Galaxy Grey marble
- Aluminium frame upholstered in FU Eco Leather (Please see Specs for details)
- Table bottom shelf, built-in drawer available in black walnut veneer
- Four castors affixed at the bottom

C06B0505 Side Table

- Top available in Carrara marble or Galaxy Grey marble
- Black metallic painted steel frame
- Table bottom shelf in black walnut
- Three castors affixed at the bottom

C06B0506 Cart

- Top available in Carrara marble or Galaxy Grey marble
- Steel-framed storage cylinder upholstered in FC Eco Leather (Please see Specs for details)
- Bottom board and shelf available in grey oak veneer
- Black metallic painted steel handles
- Cart comes with an electric glass kettle, supports self-filling and self-boiling
- Four castors affixed at the bottom

N.B.: Recommended bucket capacity less than 15L (4 gallon), MAX. Height 45cm (17.7") , MAX.
Diameter 27cm (10.6")

Kettle: Nominal Voltage: 220V ~ AC/50Hz

SIDE TABLE HARMON

Side Table
C06B0502.

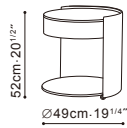

Carrara Marble + Black Walnut + FU-02
C06B0502.00.0000

Carrara Marble + Black Walnut + FU-03
C06B0502.00.0001

1,115

Galaxy Grey Marble + Black Walnut + FU-02
C06B0502.00.0002

Galaxy Grey Marble + Black Walnut + FU-03
C06B0502.00.0003

VOL. 0.2m³

Side Table
C06B0505.

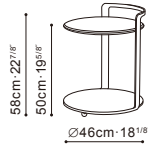

Carrara Marble + Black Walnut
C06B0505.00.0000

800

Galaxy Grey Marble + Black Walnut
C06B0505.00.0001

VOL. 0.2m³

Cart
C06B0506.

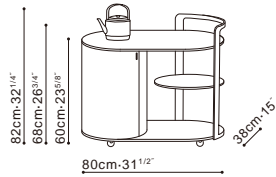

Carrara Marble + Grey Oak + FC-08
C06B0506.00.0000

2,100

Galaxy Grey Marble + Grey Oak + FC-14
C06B0506.00.0002

VOL. 0.4m³

SIDE TABLE
JOY

- Grey oak veneered top
- The middle tier available in Carrara marble
- Removable round box at the bottom in grey oak veneer only
- Steel frame in gold metallic paint with plastic glides

SIDE TABLE JOY

Side Table
C06D1301.

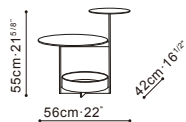

Grey Oak + Carrara Marble
C06D1301.32.0000

725

VOL. 0.15m³

SIDE TABLE PEBBLE



- Top available in Carrara marble or black walnut veneer
- Steel base in black metallic paint with plastic glides

SIDE TABLE PEBBLE

Side Table
C06A1400.



Black Walnut
C06A1400.3A.0000 600

Carrara Marble
C06A1400.3A.0002 990

VOL. 0.25m³

COFFEE TABLE RUBIX



- Top available in Carrara marble or Galaxy Grey marble
- Metal frame upholstered in FU Eco Leather (Please see Specs for details)
- Table bottom shelf available in grey oak or natural oak veneer
- Black plastic (ABS) legs

COFFEE TABLE RUBIX

Coffee Table
C06C0103.

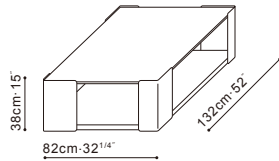

Carrara Marble + Grey Oak + FU-02
C06C0103.00.0000

Carrara Marble + Grey Oak + FU-03
C06C0103.00.0001

Carrara Marble + Natural Oak + FU-03
C06C0103.00.0002

1,855

Galaxy Grey Marble + Grey Oak + FU-02
C06C0103.00.0003

Galaxy Grey Marble + Grey Oak + FU-03
C06C0103.00.0004

VOL. 0.3m³

Coffee Table
C06C0104.

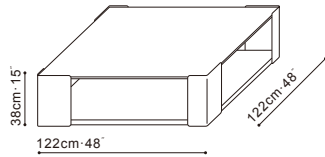

Carrara Marble + Grey Oak + FU-02
C06C0104.00.0000

Carrara Marble + Grey Oak + FU-03
C06C0104.00.0001

Carrara Marble + Natural Oak + FU-03
C06C0104.00.0002

2,065

Galaxy Grey Marble + Grey Oak + FU-02
C06C0104.00.0003

Galaxy Grey Marble + Grey Oak + FU-03
C06C0104.00.0004

VOL. 0.5m³

Side Table
C06C0105.

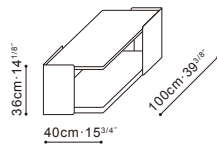

Carrara Marble + Grey Oak + FU-02
C06C0105.00.0000

Carrara Marble + Grey Oak + FU-03
C06C0105.00.0001

Carrara Marble + Natural Oak + FU-03
C06C0105.00.0002

1,015

Galaxy Grey Marble + Grey Oak + FU-02
C06C0105.00.0003

Galaxy Grey Marble + Grey Oak + FU-03
C06C0105.00.0004

VOL. 0.35m³

SIDE TABLE SLICE



- Black metallic painted steel frame upholstered in FU Eco Leather
- Grey oak veneered partition
- Black metallic painted steel feet with felt glides

SIDE TABLE SLICE

Side Table
C06H1201.

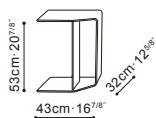

Grey Oak + FU-02

C06H1201.3A.0000

Grey Oak + FU-03

C06H1201.3A.0001

660

Grey Oak + FU-05

C06H1201.3A.0002

VOL. 0.15m³

COFFEE TABLE **SPIN**

Designed by Favaretto & Partners



- Top available in Carrara marble, Lauren Black Gold marble, or tempered glass (Please see Specs for details)
- Steel base available in black metallic paint or Eco Leather FC-13/14 upholstery with plastic glides

COFFEE TABLE SPIN

Side Table Top
C06H1006.
Side Table Base
B61H1006.



Glass		
C06H1006.00.0002	565	

Carrara Marble		
C06H1006.00.0000	640	

Lauren Black Gold Marble		
C06H1006.00.0001	700	VOL. 0.05m ³

Black Metallic Painted Steel		
B61H1006.3A.0000		

FC-13		
B61H1006.31.0001	1,025	

FC-14		
B61H1006.31.0002		VOL. 0.2m ³

Coffee Table Top
C06H1007.
Coffee Table Base
B61H1007.

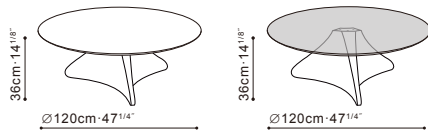

Glass		
C06H1007.00.0002	1,125	VOL. 0.2m ³

Carrara Marble		
C06H1007.00.0000	1,515	

Lauren Black Gold Marble		
C06H1007.00.0001	1,765	VOL. 0.85m ³

Black Metallic Painted Steel		
B61H1007.3A.0000		

FC-13		
B61H1007.31.0001	1,265	

FC-14		
B61H1007.31.0002		VOL. 0.35m ³

SIDE TABLE TERI



- Top available in grey oak veneer or natural oak veneer (Please see Specs for details)
- Top also available in white ceramic for C06F0404
- Solid ash wood base in grey oak or natural oak finish, comes with Teflon glides

SIDE TABLE TERI

Side Table
C06F0401.



Grey Oak
C06F0401.07.0000

----- 275

Natural Oak
C06F0401.08.0002

VOL. 0.1m³

Side Table
C06F0402.

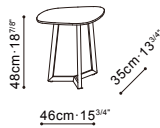

Grey Oak
C06F0402.07.0000

----- 275

Natural Oak
C06F0402.08.0002

VOL. 0.1m³

Side Table
C06F0403.



Grey Oak
C06F0403.07.0000

----- 290

Natural Oak
C06F0403.08.0002

VOL. 0.1m³

Coffee Table
C06F0404.

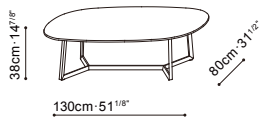

Grey Oak
C06F0404.07.0000

----- 625

Natural Oak
C06F0404.08.0002

White Ceramic+Grey Oak Color
C06F0404.07.0003

1,240

VOL. 0.2m³

COFFEE TABLE **VARY**



- Top available in Carrara marble or grey oak veneer (Please see Specs for details)
- Steel base in black metallic paint with plastic glides

SIDE TABLE VARY

Side Table
C06D1401.



Grey Oak

C06D1401.3A.0001

675

VOL. 0.15m³

Carrara Marble

C06D1401.3A.0000

1,000

VOL. 0.2m³

Coffee Table
C06D1403.

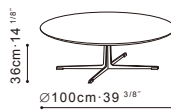

Carrara Marble

C06D1403.3A.0000

1,615

VOL. 0.8m³

Coffee Table
C06D1404.

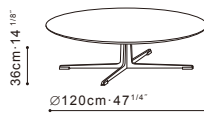

Grey Oak

C06D1404.3A.0001

1,000

VOL. 0.4m³

Carrara Marble

C06D1404.3A.0000

1,675

VOL. 0.9m³

Coffee Table
C06D1405.



Carrara Marble

C06D1405.3A.0000

1,465

VOL. 0.7m³

Coffee Table
C06D1406.

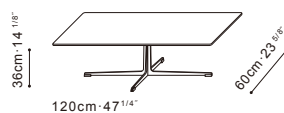

Carrara Marble

C06D1406.3A.0000

1,500

VOL. 0.7m³

VARY

Side Table
C06D1409.

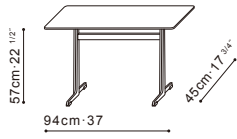

Carrara Marble
C06D1409.3A.0000

1,350

VOL. 0.6m³

Console
C06D1411.

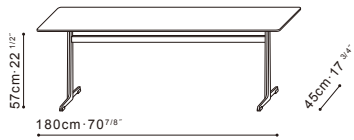

Carrara Marble
C06D1411.3A.0000

1,815

VOL. 1.3m³

TABLES

FORMA	208
HANNA	210
JOINT	212
OLIVE	214
PI	216
SPIN	218
TIME	222
UNITY	224
VARY	226
VERGE	228
VESSEL	230
WITTY	232
ZING	234

TABLE FORMA



- Oak veneered top features in solid ash wood raised edges, reinforced by internal wood frame, available in grey oak finish
- Wooden drawer available in grey oak or pine green lacquer finish, with invisible dampers drawer runners
- Solid ash wood legs in grey oak finish with plastic glides, an extra set of felt pads included in the packaging
- Drawer is necessary for C05L0102, can be mounted on either the left or right side

TABLE FORMA

Desk
C05L0101.

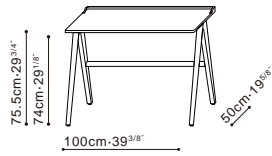

Grey Oak
C05L0101.07.0000

910

VOL. 0.25m³

Desk
C05L0102.

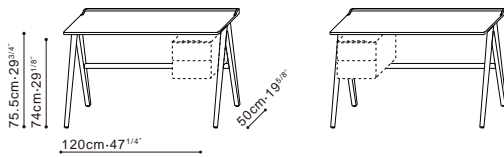

Grey Oak
C05L0102.07.0000

1,050

VOL. 0.3m³

Price doesn't include drawer.

Drawer
B52L0102.



Grey Oak
B52L0102.00.0000

295

VOL. 0.1m³

Pine Green
B52L0102.00.0001

245

Drawer is necessary for C05L0102

TABLE HANNA



- Carrara marble top
- White powder coated steel base with plastic glides

TABLE HANNA

Dining Table
C0500035.

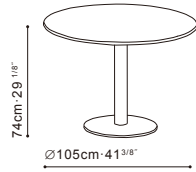

**Carrara Marble
+ White Steel**
C0500035.30.0000

1,440

VOL. 0.9m³

TABLE JOINT



- Top and solid ash wood legs reinforced with internal steel frame, available in grey oak or natural oak finish (Please see Specs for details)
- Top also available in White Ceramic
- Black metallic painted steel feet with felt glides

TABLE JOINT

Dining Table
C05C1306.

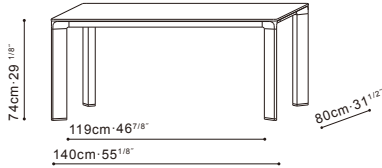

Grey Oak

C05C1306.07.0000

1,510 VOL. 0.3m³

Natural Oak

C05C1306.08.0001

White Ceramic + Grey Oak Color

C05C1306.07.0003

2,790 VOL. 0.7m³

Dining Table
C05C1301.

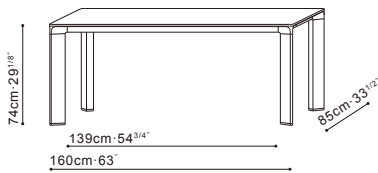

Grey Oak

C05C1301.07.0000

1,610 VOL. 0.35m³

Natural Oak

C05C1301.08.0001

White Ceramic + Grey Oak Color

C05C1301.07.0003

2,960 VOL. 0.8m³

Dining Table
C05C1307.

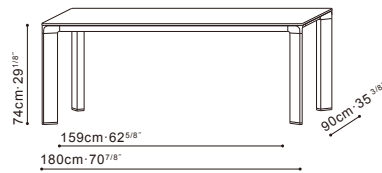

Grey Oak

C05C1307.07.0000

1,745 VOL. 0.4m³

Natural Oak

C05C1307.08.0001

White Ceramic + Grey Oak Color

C05C1307.07.0003

3,285 VOL. 1.2m³

Dining Table
C05C1303.

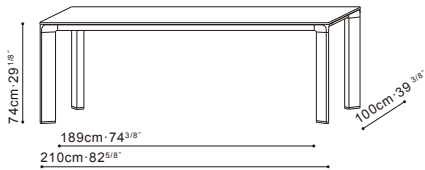

Grey Oak

C05C1303.07.0000

1,880 VOL. 0.45m³

Natural Oak

C05C1303.08.0001

White Ceramic + Grey Oak Color

C05C1303.07.0003

3,625 VOL. 1.4m³

Dining Table
C05C1304.

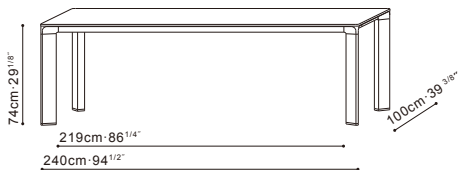

Grey Oak

C05C1304.07.0000

2,005 VOL. 0.5m³

Natural Oak

C05C1304.08.0001

White Ceramic + Grey Oak Color

C05C1304.07.0003

3,950 VOL. 1.6m³

Dining Table
C05C1305.

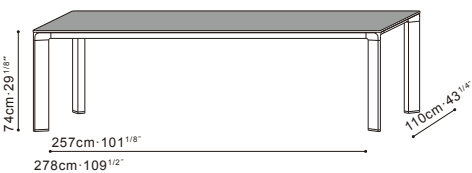

White Ceramic + Grey Oak Color

C05C1305.07.0001

4,445 VOL. 1.9m³

TABLE OLIVE



- Two heights offer different usage scenarios: dining, tea break, or relaxation
- Top available in Carrara marble or Galaxy Grey marble reinforced with internal steel frame
- Steel legs in black metallic paint with plastic glides

TABLE OLIVE

Dining Table
C05H0901.

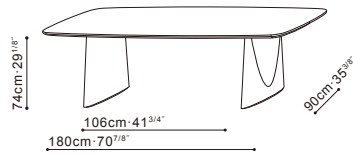

Carrara Marble

C05H0901.3A.0002

5,990

VOL. 1.05m³

Galaxy Grey Marble

C05H0901.3A.0000

Dining Table
C05H0902.

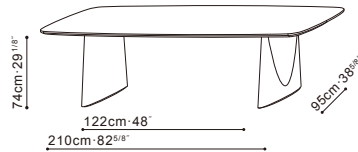

Carrara Marble

C05H0902.3A.0002

6,515

VOL. 1.25m³

Galaxy Grey Marble

C05H0902.3A.0000

Dining Table
C05H0903.

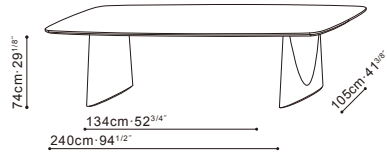

Carrara Marble

C05H0903.3A.0002

7,040

VOL. 1.55m³

Galaxy Grey Marble

C05H0903.3A.0000

Dining Table
C05H0904.

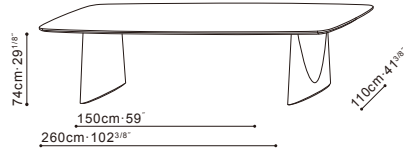

Carrara Marble

C05H0904.3A.0002

7,565

VOL. 1.85m³

Galaxy Grey Marble

C05H0904.3A.0000

Low Dining Table
C05H0905.

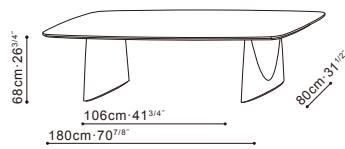

Carrara Marble

C05H0905.3A.0001

5,075

VOL. 1.05m³

Galaxy Grey Marble

C05H0905.3A.0000

Low Dining Table
C05H0906.

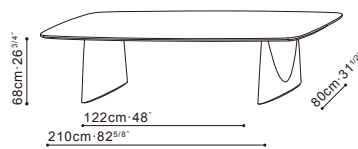

Carrara Marble

C05H0906.3A.0001

5,600

VOL. 1.25m³

Galaxy Grey Marble

C05H0906.3A.0000

Low Dining Table
C05H0907.

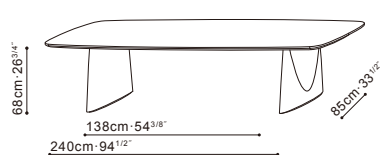

Carrara Marble

C05H0907.3A.0001

6,125

VOL. 1.55m³

Galaxy Grey Marble

C05H0907.3A.0000

TABLE
PI

- Oak veneered top reinforced with internal steel frame
- Oak veneered base reinforced with solid ash wood
- Available in grey oak or natural oak finish
- Teflon glides installed at the bottom

TABLE PI

Dining Table
C05C0601.

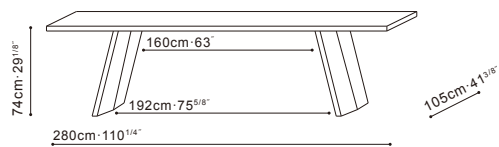

Grey Oak

C05C0601.07.0000

2,490

VOL. 0.5m³

Natural Oak

C05C0601.08.0001

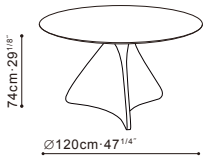
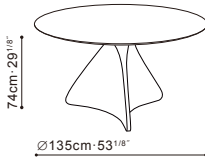

TABLE
SPIN

Designed by Favaretto & Partners



- Top available in Carrara marble or Lauren Black Gold marble (Please see Specs for details)
- Steel base available in black metallic paint or Eco Leather FC-13/14 upholstery with plastic glides

TABLE SPIN

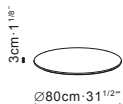
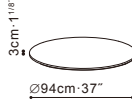
Dining Table Top C05H1001. Dining Table Base B51H1001.		Carrara Marble C05H1001.00.0000 3,275 VOL. 0.85m ³
		Black Metallic Painted Steel B51H1001.3A.0000 ----- FC-13 B51H1001.31.0001 1,825 ----- FC-14 B51H1001.31.0002 VOL. 0.75m ³
Dining Table Top C05H1002. Dining Table Base B51H1001.		Carrara Marble C05H1002.00.0000 3,800 VOL. 0.95m ³
		Black Metallic Painted Steel B51H1001.3A.0000 ----- FC-13 B51H1001.31.0001 1,825 ----- FC-14 B51H1001.31.0002 VOL. 0.75m ³
Dining Table Top C05H1003. Dining Table Base B51H1003.		Carrara Marble C05H1003.00.0000 4,400 VOL. 1.35m ³
		Black Metallic Painted Steel B51H1003.3A.0000 ----- FC-13 B51H1003.31.0001 2,290 ----- FC-14 B51H1003.31.0002 VOL. 1.1m ³
Lazy Susan B50H1008.	 <p>For C05H1002 only</p>	Carrara Marble B50H1008.00.0000 990 VOL. 0.1m ³
Lazy Susan B50H1009.	 <p>For C05H1003 only</p>	Carrara Marble B50H1009.00.0000 1,240 VOL. 0.35m ³

SPIN

Dining Table Top
C05H1004.

Dining Table Base
B51H1004.

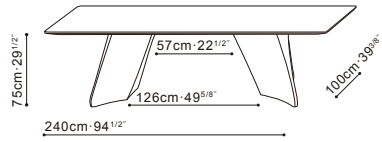

Lauren Black Gold Marble

C05H1004.00.0000

5,100 VOL. 1.35m³

Black Metallic Painted Steel

B51H1004.3A.0000

FC-13

B51H1004.31.0001

2,640

FC-14

B51H1004.31.0002

VOL. 0.9m³

Dining Table Top
C05H1005.

Dining Table Base
B51H1004.

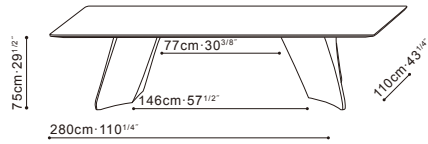

Lauren Black Gold Marble

C05H1005.00.0000

6,165 VOL. 1.7m³

Black Metallic Painted Steel

B51H1004.3A.0000

FC-13

B51H1004.31.0001

2,640

FC-14

B51H1004.31.0002

VOL. 0.9m³

TABLE
TIME

- Top, with a cord management opening, available in grey oak, natural oak, or graphite oak veneer
- With the exception to C05D1104 and C05D1105, tops reinforced with internal steel frame
- Steel legs in black or CHP(Champagne) Silver metallic paint with plastic glides
- Wooden base and optional drawer available in grey oak, natural oak, or graphite oak veneer; base comes with Teflon glides
- Box base is necessary for the Time series

TABLE TIME

<p>Desk C05D1101.</p>  <p>Price doesn't include box base and drawer.</p>	<p>Grey Oak + Black Metallic Painted Steel C05D1101.3A.0000</p> <p>-----</p> <p>Natural Oak + CHP Silver Metallic Painted Steel C05D1101.35.0001</p> <p>-----</p> <p>Graphite Oak + Black Metallic Painted Steel C05D1101.3A.0002</p> <p>-----</p> <p>1,680</p> <p>2,345</p> <p>VOL. 0.5m³</p>
<p>Desk C05D1102.</p>  <p>Price doesn't include box base and drawer.</p>	<p>Grey Oak + Black Metallic Painted Steel C05D1102.3A.0000</p> <p>-----</p> <p>Natural Oak + CHP Silver Metallic Painted Steel C05D1102.35.0001</p> <p>-----</p> <p>Graphite Oak + Black Metallic Painted Steel C05D1102.3A.0002</p> <p>-----</p> <p>1,610</p> <p>2,240</p> <p>VOL. 0.45m³</p>
<p>Desk C05D1103.</p>  <p>Price doesn't include box base and drawer.</p>	<p>Grey Oak + Black Metallic Painted Steel C05D1103.3A.0000</p> <p>-----</p> <p>Natural Oak + CHP Silver Metallic Painted Steel C05D1103.35.0001</p> <p>-----</p> <p>Graphite Oak + Black Metallic Painted Steel C05D1103.3A.0002</p> <p>-----</p> <p>1,540</p> <p>2,135</p> <p>VOL. 0.4m³</p>
<p>Desk C05D1104.</p>  <p>Price doesn't include box base and drawer.</p>	<p>Grey Oak + Black Metallic Painted Steel C05D1104.3A.0000</p> <p>-----</p> <p>Natural Oak + CHP Silver Metallic Painted Steel C05D1104.35.0001</p> <p>-----</p> <p>Graphite Oak + Black Metallic Painted Steel C05D1104.3A.0002</p> <p>-----</p> <p>1,120</p> <p>1,470</p> <p>VOL. 0.35m³</p>
<p>Desk C05D1105.</p>  <p>Price doesn't include box base and drawer.</p>	<p>Grey Oak + Black Metallic Painted Steel C05D1105.3A.0000</p> <p>-----</p> <p>Natural Oak + CHP Silver Metallic Painted Steel C05D1105.35.0001</p> <p>-----</p> <p>Graphite Oak + Black Metallic Painted Steel C05D1105.3A.0002</p> <p>-----</p> <p>1,050</p> <p>1,365</p> <p>VOL. 0.3m³</p>
<p>Drawer B52D1107.</p>  <p>Optional Drawer</p>	<p>Grey Oak B52D1107.00.0000</p> <p>-----</p> <p>Natural Oak B52D1107.00.0001</p> <p>-----</p> <p>Graphite Oak B52D1107.00.0002</p> <p>-----</p> <p>140</p> <p>210</p> <p>VOL. 0.05m³</p>
<p>Box Base B51D1108.</p>  <p>Box base is necessary for the Time series.</p>	<p>Grey Oak B51D1108.07.0000</p> <p>-----</p> <p>Natural Oak B51D1108.08.0001</p> <p>-----</p> <p>Graphite Oak B51D1108.06.0002</p> <p>-----</p> <p>315</p> <p>560</p> <p>VOL. 0.1m³</p>

TABLE UNITY



- Top for C05B0803 and C05B0806 available in Carrara marble, Galaxy Grey marble, or grey oak veneer
- Top for C05B0804 and C05B0805 available in graphite oak veneer and white ceramic Combo
- Electric lifted Lazy Susan for C05B0804 and C05B0805 helps cleaning up the hidden space, load bearing $\leq 60\text{KG}$ when lifting
- Optional grey oak finished Lazy Susan B50B0807 devoted to C05B0803
- Solid ash wood support brackets available in grey oak or graphite oak finish
- MDF base with plywood reinforcement upholstered in black Eco Leather FC-11, comes with Teflon glides

TABLE UNITY

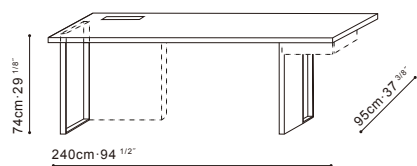
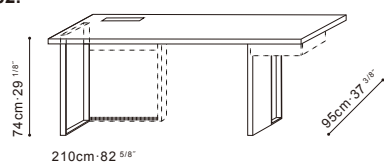
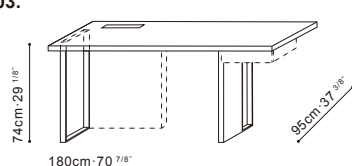
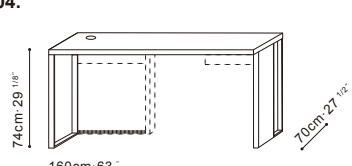
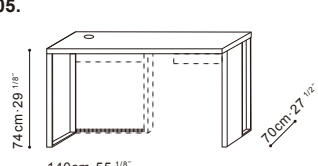
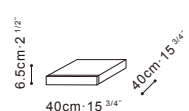
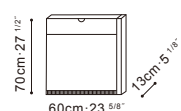
Dining Table
C05B0804.

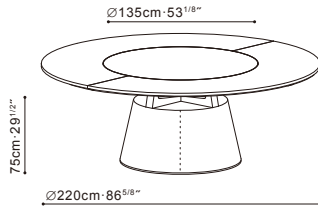

White Ceramic + Graphite Oak
C05B0804.31.0001 8,400

VOL. 2.0m³

Dining Table
C05B0805.

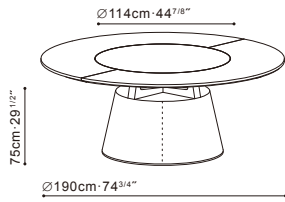

White Ceramic + Graphite Oak
C05B0805.31.0001 7,350

VOL. 1.75m³

Dining Table
C05B0803.

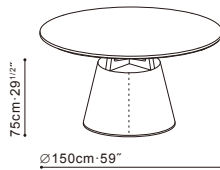

Grey Oak
C05B0803.31.0000 1,995 VOL. 0.65m³

Carrara Marble + Grey Oak Color
C05B0803.31.0001 3,270

Galaxy Grey Marble + Grey Oak Color
C05B0803.31.0002 VOL. 1.5m³

Lazy Susan
B50B0807.

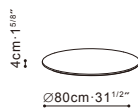

Grey Oak
B50B0807.00.0000 350

VOL. 0.07m³

For C05B0803.only

Dining Table
C05B0806.

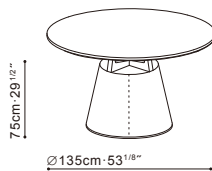

Grey Oak
C05B0806.31.0000 1,575 VOL. 0.55m³

Carrara Marble + Grey Oak Color
C05B0806.31.0001 3,090

Galaxy Grey Marble + Grey Oak Color
C05B0806.31.0002 VOL. 1.2m³

TABLE
VARY

- Carrara marble top
- Steel base in black metallic paint with plastic glides

TABLE VARY

Bistro Table
C05D1408.

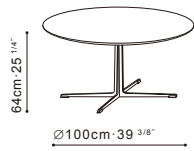

Carrara Marble
C05D1408.3A.0000

1,600

VOL. 0.8m³

Dining Table
C05D1412.

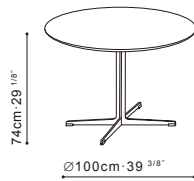

Carrara Marble
C05D1412.3A.0000

2,140

VOL. 0.9m³

TABLE VERGE



Dining Tables

- Top available in Carrara marble or black walnut veneer
- Solid ash wood legs available in black walnut finish
- Teflon glides installed at the bottom

Desk

- Top and drawer available in black walnut veneer
- Steel legs in black metallic paint with plastic glides

TABLE VERGE

Desk

C05A0801.

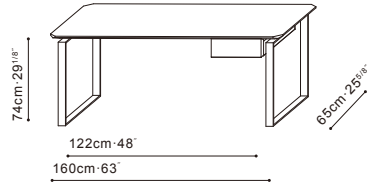

Black Walnut
C05A0801.3A.0000

1,330

VOL. 0.4m³

Dining Table

C05A0806.

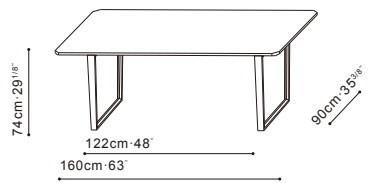

Black Walnut
C05A0806.09.0000

1,470

VOL. 0.45m³

**Carrara Marble +
Black Walnut Color**
C05A0806.09.0001

2,975

VOL. 1.1m³

Dining Table

C05A0807.

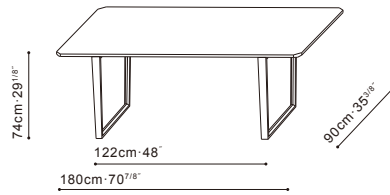

Black Walnut
C05A0807.09.0000

1,540

VOL. 0.5m³

**Carrara Marble +
Black Walnut Color**
C05A0807.09.0001

3,150

VOL. 1.25m³

Dining Table

C05A0803.

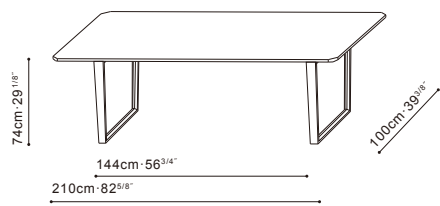

Black Walnut
C05A0803.09.0000

1,645

VOL. 0.65m³

**Carrara Marble +
Black Walnut Color**
C05A0803.09.0001

3,325

VOL. 1.5m³

Dining Table

C05A0804.

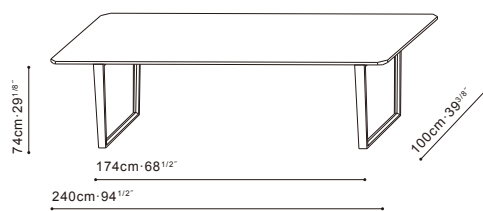

Black Walnut
C05A0804.09.0000

1,785

VOL. 0.75m³

**Carrara Marble +
Black Walnut Color**
C05A0804.09.0001

3,500

VOL. 1.7m³

TABLE VESSEL



- Oak veneered top and drawer, solid ash wood base
- Available in grey oak finish
- Teflon glides installed at the bottom

TABLE VESSEL

Desk
C0552014.

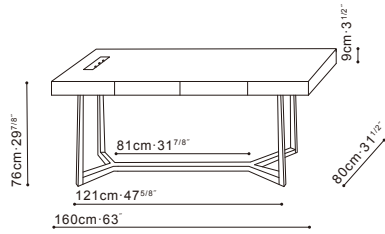

Grey Oak
C0552014.07.0000

1,505

VOL. 0.45m³

Desk
C0552015.

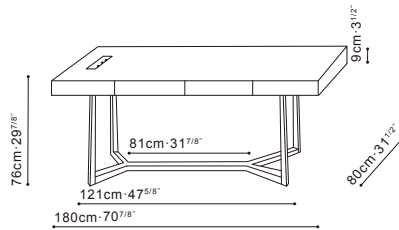

Grey Oak
C0552015.07.0000

1,610

VOL. 0.5m³

Desk
C0552017.

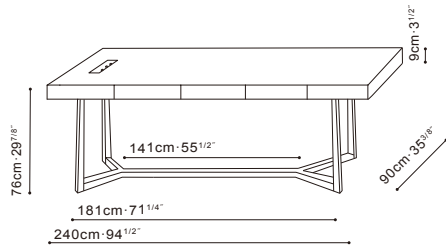

Grey Oak
C0552017.07.0000

2,100

VOL. 0.7m³

Desk
C0552018.

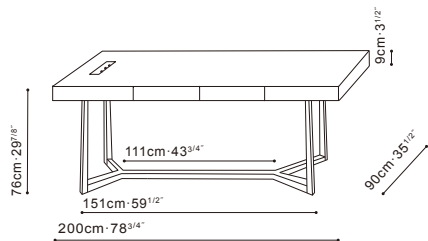

Grey Oak
C0552018.07.0000

1,925

VOL. 0.6m³

DESK WITTY



- Top board available in grey oak or graphite oak veneer
- The rest of top in matte Dove lacquer
- Drawer interior decorated in driftwood melamine
- Invisible drawer runners with dampers
- Steel base in black metallic paint with plastic glides

DESK WITTY

Desk
C05H1101.

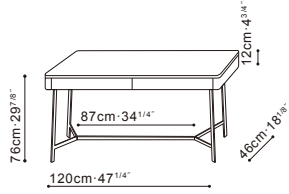

Graphite Oak + Dove
C05H1101.3A.0001

----- 1,375

Grey Oak + Dove
C05H1101.3A.0000

VOL. 0.25m³

Desk
C05H1102.

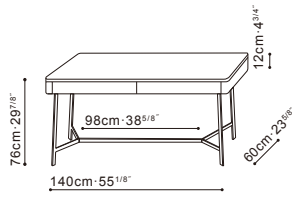

Graphite Oak + Dove
C05H1102.3A.0001

----- 1,625

Grey Oak + Dove
C05H1102.3A.0000

VOL. 0.35m³

TABLE
ZING

- Galaxy Grey marble top
- Black powder coated steel base with plastic glides, height slightly adjustable for uneven floors

TABLE ZING

Dining Table
C05D1203.

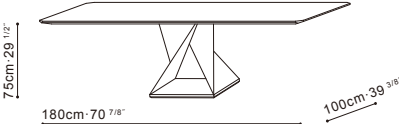

Galaxy Grey Marble
C05D1203.31.0001

4,270

VOL. 1.4m³

Dining Table
C05D1204.

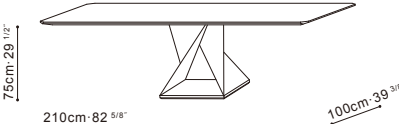

Galaxy Grey Marble
C05D1204.31.0001

4,480

VOL. 1.6m³

CABINETS

CONTENT	238
MATRIX	240
MAX	250
PIXEL	252
SEASON	256

CABINET CONTENT

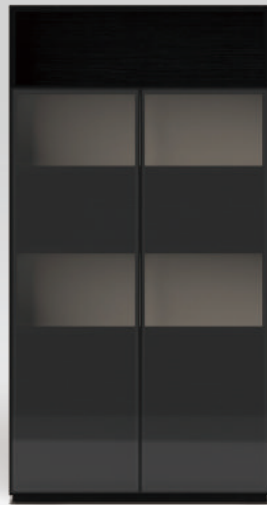

A fresh-looking library, where books and decorations become the protagonists thanks to the clear glass door, expands your modern styled room to include more storage space.

Construction:

Frame

- Available in matte Tuscan Tan lacquer and grey oak veneer combination, matte Dove lacquer and graphite oak veneer combination, or natural oak veneer, for C0400103 and C0400104
- Tempered transparent glass doors in aluminium frame, available in black or grey color
- Charcoal melamine, tempered transparent glass door and shelves with black aluminium frame for C0400106

Drawer

- Push-pull drawer with invisible drawer runners
- Drawer front available in matte Tuscan Tan lacquer, Dove lacquer or natural oak for C0400104
- Melamine drawer structure

Leg

- Adjustable black plastic (ABS) hidden legs

Hardware

- Damper hinges with integrated soft-close mechanism, 105° opening

N.B.: C0400106 comes with LED light

CABINET CONTENT

Display Cabinet
C0400103.

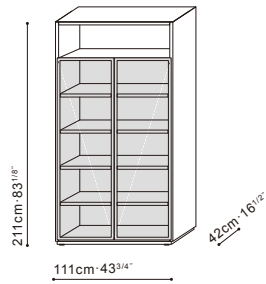

**Grey Oak + Tuscan Tan
+ Black Aluminium Framed Glass Door**
C0400103.00.0000

4,300

**Natural Oak +
Grey Aluminium Framed Glass Door**
C0400103.00.0001

**Graphite Oak + Dove
+Black Aluminium Framed Glass Door**
C0400103.00.0002

5,770

VOL. 0.6m³

Display Cabinet
C0400104.

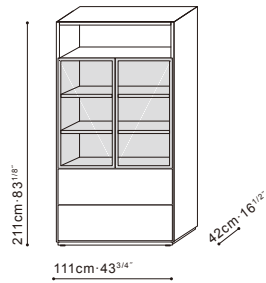

**Grey Oak + Tuscan Tan
+ Black Aluminium Framed Glass Door**
C0400104.00.0000

4,650

**Natural Oak +
Grey Aluminium Framed Glass Door**
C0400104.00.0001

**Graphite Oak + Dove
+Black Aluminium Framed Glass Door**
C0400104.00.0002

6,230

VOL. 0.7m³

Display Cabinet
C0400106.

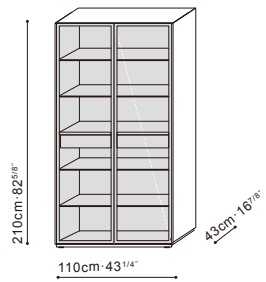

**Charcoal +
Black Aluminium Framed Glass Door**
C0400106.00.0000

3,255

VOL. 0.6m³

CABINET MATRIX



Thanks to its wide variety of materials that can be combined to create personalized solutions, MATRIX is the perfect system that enhances the object that should be displayed and gives the possibility to store and hide what needs to be preserved. The ultimate living solution perfectly balances aesthetic and functionality.

Construction:

Frame

- Top available in marble, lacquer finish, or oak veneer (Please see Specs for details)
- Wood doors, side boards and upper backboard available in oak veneer or lacquer finish (Please see Specs for details)
- Backboard and inner structure in Driftwood, Charcoal or Burlywood melamine
- Tempered transparent glass shelves for C04H0807, C04H0808, C04H0809, C04H0810, C04H0811 and C04H0812
- C04H0811 comes with mirror decoration
- Tempered transparent grey glass doors in black aluminium frame for C04H0812

Drawer

- Invisible drawer runners with dampers
- Drawer front available in oak veneer or lacquer finish
- Drawer structure in Driftwood or Charcoal melamine

Leg

- Grey or CHP (Champagne) silver metallic painted steel legs with plastic glides, height slightly adjustable for uneven floors
- Invisible melamine base for certain cabinets

Hardware

- Damper hinges for wood doors
- Damper hinges with integrated soft-close mechanism for glass doors, 105° opening
- Grey or CHP (Champagne) silver metallic painted steel handles

- N.B. • C04H0811 comes with LED light
- C04H0812 comes with infrared sensor light

CABINET MATRIX

TV Stand C04H0801.

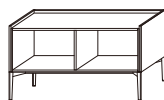
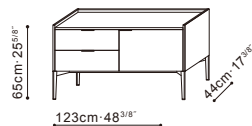

Internal Structure



Cabinet (Without Top & Leg)

Dove + Driftwood

C04H0801.00.0000

Price (EURO) 770

VOL. 0.2m³



Cabinet Top

Dove

B40H0801.00.0000

Price (EURO) 210

VOL. 0.05m³



Cabinet Leg

Grey Metallic Painted Steel

B41H0801.34.0000

Price (EURO) 595

VOL. 0.1m³

TV Stand C04H0802.

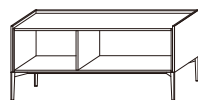
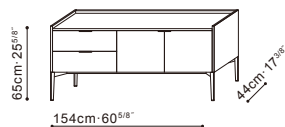

Internal Structure



Cabinet (Without Top & Leg)

Dove + Driftwood

C04H0802.00.0000

Price (EURO) 840

VOL. 0.25m³



Cabinet Top

Dove

B40H0802.00.0000

Price (EURO) 280

VOL. 0.05m³



Cabinet Leg

Grey Metallic Painted Steel

B41H0802.34.0000

Price (EURO) 665

VOL. 0.1m³

MATRIX

TV Stand

C04H0803.(High Feet)

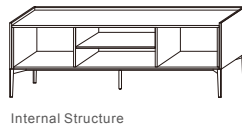
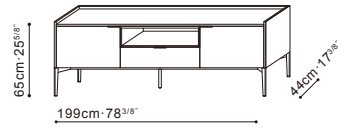

Internal Structure

TV Stand

C04H0803.(Low Feet)

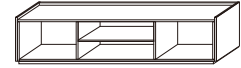
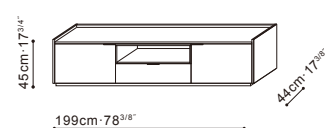

Internal Structure

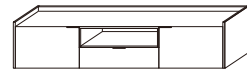

Cabinet (Without Top & Leg)

Dove + Driftwood

C04H0803.00.0000

Price (EURO) 910
VOL. 0.3m³

Dove + Graphite Oak + Driftwood

C04H0803.00.0001

Price (EURO) 1,085
VOL. 0.3m³



Cabinet Top

Dove

B40H0803.00.0000

Price (EURO) 350
VOL. 0.1m³

Carrara Marble

B40H0803.00.0001

Price (EURO) 840
VOL. 0.65m³

Galaxy Grey Marble

B40H0803.00.0002

Price (EURO) 840
VOL. 0.65m³



Cabinet Leg

Grey Metallic Painted Steel

B41H0803.34.0000

Price (EURO) 735
VOL. 0.1m³



Cabinet Base

Driftwood

B41H0803.20.0001

Price (EURO) 85
VOL. 0.1m³

TV Stand

C04H0804.(High Feet)

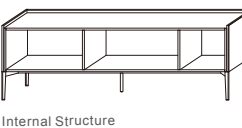
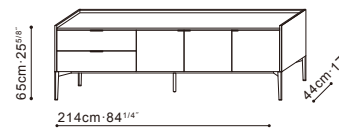

Internal Structure

TV Stand

C04H0804.(Low Feet)

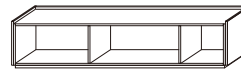
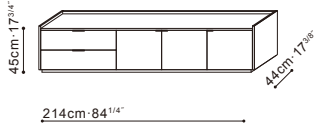

Internal Structure



Cabinet (Without Top & Leg)

Dove + Driftwood

C04H0804.00.0000

Price (EURO) 1,085
VOL. 0.35m³

Dove + Graphite Oak + Driftwood

C04H0804.00.0001

Price (EURO) 1,295
VOL. 0.35m³

Natural Oak + Burlywood

C04H0804.00.0002

Price (EURO) 1,295
VOL. 0.35m³



Cabinet Top

Dove

B40H0804.00.0000

Price (EURO) 420
VOL. 0.1m³

Carrara Marble

B40H0804.00.0001

Price (EURO) 910
VOL. 0.7m³

Galaxy Grey Marble

B40H0804.00.0002

Price (EURO) 910
VOL. 0.7m³

Natural Oak

B40H0804.00.0004

Price (EURO) 490
VOL. 0.1m³



Cabinet Leg

Grey Metallic Painted Steel

B41H0804.34.0000

Price (EURO) 770
VOL. 0.1m³

CHP Silver Metallic Painted Steel

B41H0804.35.0001

Price (EURO) 770
VOL. 0.1m³

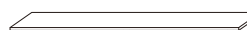

Cabinet Base

Driftwood

B41H0804.20.0002

Price (EURO) 100
VOL. 0.1m³

Burlywood

B41H0804.22.0004

Price (EURO) 100
VOL. 0.1m³

TV Stand
C04H0805.(High Feet)

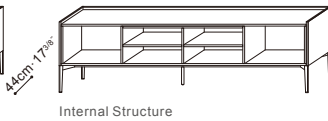
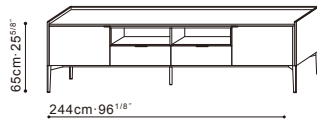

TV Stand
C04H0805. (Low Feet)

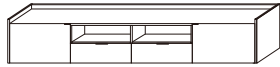
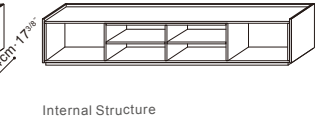
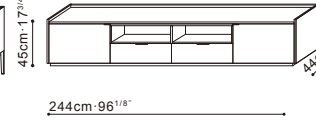

Cabinet (Without Top & Leg)

Dove + Driftwood

C04H0805.00.0000

Price (EURO) 1,155
VOL. 0.4m³

Dove + Graphite Oak + Driftwood

C04H0805.00.0001

Price (EURO) 1,400
VOL. 0.4m³



Cabinet Top

Dove

B40H0805.00.0000

Price (EURO) 490
VOL. 0.1m³

Carrara Marble

B40H0805.00.0001

Price (EURO) 1,050
VOL. 0.8m³

Galaxy Grey Marble

B40H0805.00.0002

Price (EURO) 1,050
VOL. 0.8m³



Cabinet Leg

Grey Metallic Painted Steel

B41H0805.34.0000

Price (EURO) 805
VOL. 0.15m³



Cabinet Base

Driftwood

B41H0805.20.0001

Price (EURO) 120
VOL. 0.1m³

TV Stand
C04H0806.(High Feet)

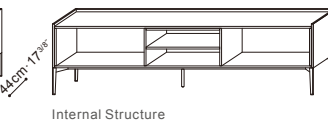
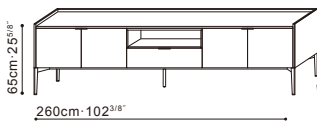

TV Stand
C04H0806. (Low Feet)

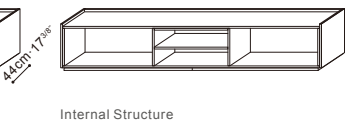
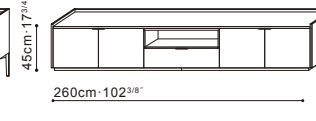

Cabinet (Without Top & Leg)

Dove + Driftwood

C04H0806.00.0000

Price (EURO) 1,295
VOL. 0.45m³

Dove + Graphite Oak + Driftwood

C04H0806.00.0001

Price (EURO) 1,575
VOL. 0.45m³

Natural Oak + Burlywood

C04H0806.00.0002

Price (EURO) 1,575
VOL. 0.45m³



Cabinet Top

Dove

B40H0806.00.0000

Price (EURO) 560
VOL. 0.15m³

Carrara Marble

B40H0806.00.0001

Price (EURO) 1,155
VOL. 0.85m³

Galaxy Grey Marble

B40H0806.00.0002

Price (EURO) 1,155
VOL. 0.85m³

Natural Oak

B40H0806.00.0003

Price (EURO) 665
VOL. 0.15m³



Cabinet Leg

Grey Metallic Painted Steel

B41H0806.34.0000

Price (EURO) 840
VOL. 0.15m³

CHP Silver Metallic Painted Steel

B41H0806.35.0001

Price (EURO) 840
VOL. 0.15m³



Cabinet Base

Driftwood

B41H0806.20.0002

Price (EURO) 140
VOL. 0.1m³

Burlywood

B41H0806.22.0003

Price (EURO) 140
VOL. 0.1m³

MATRIX

Sideboard

C04H0807.

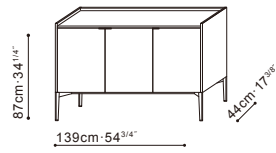

Internal Structure

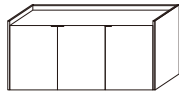

Cabinet (Without Top & Leg)

Dove + Driftwood

C04H0807.00.0000

Price (EURO) 1,015

VOL. 0.25m³

Smoke + Charcoal

C04H0807.00.0001

Price (EURO) 1,015

VOL. 0.25m³



Cabinet Top

Dove

B40H0807.00.0000

Price (EURO) 245

VOL. 0.05m³

Smoke

B40H0807.00.0003

Price (EURO) 245

VOL. 0.05m³

Carrara Marble

B40H0807.00.0001

Price (EURO) 595

VOL. 0.45m³

Galaxy Grey Marble

B40H0807.00.0002

Price (EURO) 595

VOL. 0.45m³



Cabinet Leg

Grey Metallic Painted Steel

B41H0807.34.0000

Price (EURO) 630

VOL. 0.1m³

Sideboard

C04H0819.

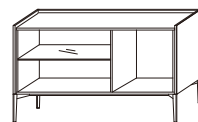
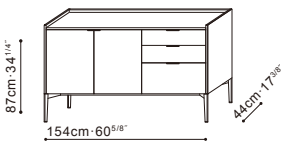

Cabinet (Without Top & Leg)

Dove + Driftwood

C04H0819.00.0000

Price (EURO) 1,190

VOL. 0.3m³

Smoke + Charcoal

C04H0819.00.0001

Price (EURO) 1,190

VOL. 0.3m³



Cabinet Top

Dove

B40H0802.00.0000

Price (EURO) 280

VOL. 0.05m³

Smoke

B40H0802.00.0001

Price (EURO) 280

VOL. 0.05m³



Cabinet Leg

Grey Metallic Painted Steel

B41H0802.34.0000

Price (EURO) 665

VOL. 0.1m³

Sideboard
C04H0808.

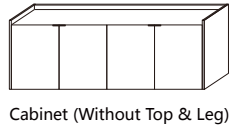
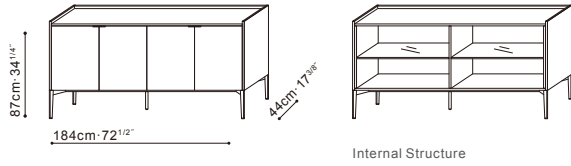

Cabinet (Without Top & Leg)

Dove + Driftwood
C04H0808.00.0000
Price (EURO) 1,225
VOL. 0.3m³

Smoke + Charcoal
C04H0808.00.0001
Price (EURO) 1,225
VOL. 0.3m³



Cabinet Top

Dove
B40H0808.00.0000
Price (EURO) 315
VOL. 0.1m³

Smoke
B40H0808.00.0003
Price (EURO) 315
VOL. 0.1m³

Carrara Marble
B40H0808.00.0001
Price (EURO) 770
VOL. 0.5m³

Galaxy Grey Marble
B40H0808.00.0002
Price (EURO) 770
VOL. 0.5m³



Cabinet Leg

Grey Metallic Painted Steel
B41H0808.34.0000
Price (EURO) 700
VOL. 0.1m³

Sideboard
C04H0809.(High Feet)

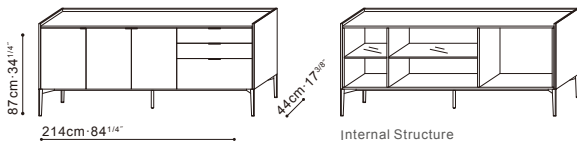

Cabinet (Without Top & Leg)

Dove + Driftwood
C04H0809.00.0000
Price (EURO) 1,575
VOL. 0.4m³

Smoke + Charcoal
C04H0809.00.0001
Price (EURO) 1,575
VOL. 0.4m³

Sideboard
C04H0809.(Low Feet)

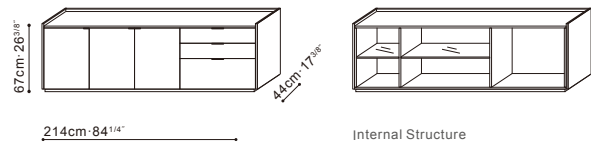

Natural Oak + Burlywood
C04H0809.00.0002
Price (EURO) 1,890
VOL. 0.4m³



Cabinet Top

Dove
B40H0804.00.0000
Price (EURO) 420
VOL. 0.1m³

Smoke
B40H0804.00.0003
Price (EURO) 420
VOL. 0.1m³

Carrara Marble
B40H0804.00.0001
Price (EURO) 910
VOL. 0.7m³

Galaxy Grey Marble
B40H0804.00.0002
Price (EURO) 910
VOL. 0.7m³

Natural Oak
B40H0804.00.0004
Price (EURO) 490
VOL. 0.1m³



Cabinet Leg

Grey Metallic Painted Steel
B41H0804.34.0000
Price (EURO) 770
VOL. 0.1m³

CHP Silver Metallic Painted Steel
B41H0804.35.0001
Price (EURO) 770
VOL. 0.1m³



Cabinet Base

Driftwood
B41H0804.20.0002
Price (EURO) 100
VOL. 0.1m³

Charcoal
B41H0804.21.0003
Price (EURO) 100
VOL. 0.1m³

Burlywood
B41H0804.22.0004
Price (EURO) 100
VOL. 0.1m³

MATRIX

Sideboard

C04H0810.(High Feet)

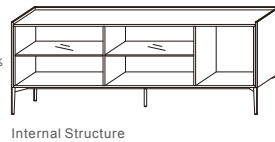
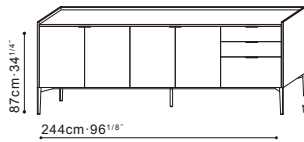

Internal Structure

Sideboard

C04H0810.(Low Feet)

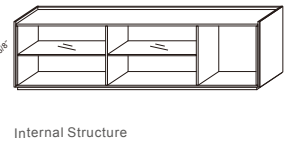
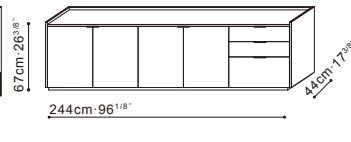

Internal Structure

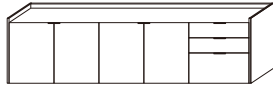

Cabinet (Without Top & Leg)

Dove + Driftwood

C04H0810.00.0000

Price (EURO) 1,785

VOL. 0.45m³

Smoke + Charcoal

C04H0810.00.0001

Price (EURO) 1,785

VOL. 0.45m³



Cabinet Top

Dove

B40H0805.00.0000

Price (EURO) 490

VOL. 0.1m³

Smoke

B40H0805.00.0003

Price (EURO) 490

VOL. 0.1m³

Carrara Marble

B40H0805.00.0001

Price (EURO) 1,050

VOL. 0.8m³

Galaxy Grey Marble

B40H0805.00.0002

Price (EURO) 1,050

VOL. 0.8m³



Cabinet Leg

Grey Metallic Painted Steel

B41H0805.34.0000

Price (EURO) 805

VOL. 0.15m³



Cabinet Base

Driftwood

B41H0805.20.0001

Price (EURO) 120

VOL. 0.1m³

Charcoal

B41H0805.21.0002

Price (EURO) 120

VOL. 0.1m³

Sideboard

C04H0811.

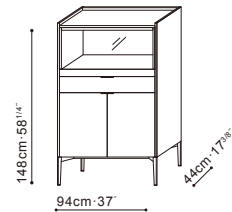

Internal Structure

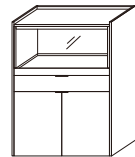

Cabinet (Without Shelf & Leg)

Smoke + Charcoal

C04H0811.00.0000

Price (EURO) 1,680

VOL. 0.35m³

Pine Green + Graphite Oak + Charcoal

C04H0811.00.0001

Price (EURO) 2,100

VOL. 0.35m³

Natural Oak + Burlywood

C04H0811.00.0002

Price (EURO) 2,100

VOL. 0.35m³



Cabinet Shelf

Carrara Marble

B40H0811.00.0000

Price (EURO) 385

VOL. 0.1m³

Galaxy Grey Marble

B40H0811.00.0001

Price (EURO) 385

VOL. 0.1m³



Cabinet Leg

Grey Metallic Painted Steel

B41H0811.34.0000

Price (EURO) 560

VOL. 0.05m³

CHP Silver Metallic Painted Steel

B41H0811.35.0001

Price (EURO) 560

VOL. 0.05m³

Display Cabinet
C04H0812.

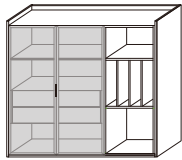
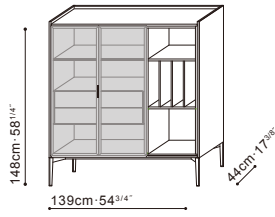

Cabinet (Without Top & Leg)

Graphite Oak + Charcoal

C04H0812.00.0000

Price (EURO) 4,095

VOL. 0.65m³



Cabinet Top

Graphite Oak

B40H0812.00.0000

Price (EURO) 350

VOL. 0.05m³



Cabinet Leg

Grey Metallic Painted Steel

B41H0807.34.0000

Price (EURO) 630

VOL. 0.1m³

Drawer Cabinet
C04H0813.



Internal Structure



Cabinet (Without Top)

Dove + Driftwood

C04H0813.34.0000

Price (EURO) 910

VOL. 0.18m³

Pine Green + Charcoal

C04H0813.34.0001

Price (EURO) 910

VOL. 0.18m³



Cabinet Top

Dove

B40H0813.00.0000

Price (EURO) 100

VOL. 0.02m³

Pine Green

B40H0813.00.0002

Price (EURO) 100

VOL. 0.02m³

MATRIX

Drawer Cabinet C04H0814.

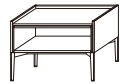
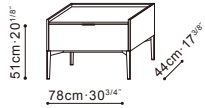

Internal Structure

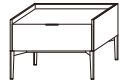

Cabinet (Without Top)

Dove + Driftwood
C04H0814.34.0000
Price (EURO) 1,015
VOL. 0.27m³

Pine Green + Charcoal
C04H0814.34.0001
Price (EURO) 1,015
VOL. 0.27m³



Cabinet Top

Dove
B40H0814.00.0000
Price (EURO) 140
VOL. 0.03m³

Pine Green
B40H0814.00.0005
Price (EURO) 140
VOL. 0.03m³

Carrara Marble
B40H0814.00.0001
Price (EURO) 350
VOL. 0.08m³

Galaxy Grey Marble
B40H0814.00.0002
Price (EURO) 350
VOL. 0.08m³

Drawer Cabinet C04H0815.

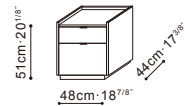

Internal Structure



Cabinet (Without Top)

Dove + Driftwood
C04H0815.00.0000
Price (EURO) 560
VOL. 0.18m³

Pine Green + Charcoal
C04H0815.00.0001
Price (EURO) 560
VOL. 0.18m³

Natural Oak + Burlywood
C04H0815.00.0002
Price (EURO) 665
VOL. 0.18m³



Cabinet Top

Dove
B40H0813.00.0000
Price (EURO) 100
VOL. 0.02m³

Pine Green
B40H0813.00.0002
Price (EURO) 100
VOL. 0.02m³

Natural Oak
B40H0813.00.0001
Price (EURO) 120
VOL. 0.02m³

Drawer Cabinet C04H0816.

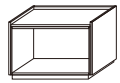
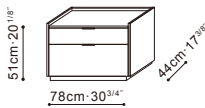

Internal Structure

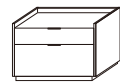

Cabinet (Without Top)

Dove + Driftwood
C04H0816.00.0000
Price (EURO) 665
VOL. 0.27m³

Pine Green + Charcoal
C04H0816.00.0001
Price (EURO) 665
VOL. 0.27m³

Natural Oak + Burlywood
C04H0816.00.0002
Price (EURO) 805
VOL. 0.27m³



Cabinet Top

Dove
B40H0814.00.0000
Price (EURO) 140
VOL. 0.03m³

Pine Green
B40H0814.00.0005
Price (EURO) 140
VOL. 0.03m³

Carrara Marble
B40H0814.00.0001
Price (EURO) 350
VOL. 0.08m³

Galaxy Grey Marble
B40H0814.00.0002
Price (EURO) 350
VOL. 0.08m³

Natural Oak
B40H0814.00.0003
Price (EURO) 175
VOL. 0.03m³

Drawer Cabinet
C04H0817.

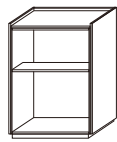
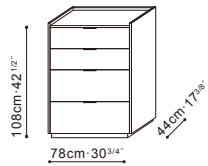

Internal Structure



Cabinet (Without Top)

Dove + Graphite Oak + Driftwood

C04H0817.00.0000

Price (EURO) 1,505

VOL. 0.32m³



Cabinet Top

Dove

B40H0814.00.0000

Price (EURO) 140

VOL. 0.03m³

Graphite Oak

B40H0814.00.0004

Price (EURO) 210

VOL. 0.03m³

Carrara Marble

B40H0814.00.0001

Price (EURO) 350

VOL. 0.08m³

Galaxy Grey Marble

B40H0814.00.0002

Price (EURO) 350

VOL. 0.08m³

Drawer Cabinet
C04H0818.

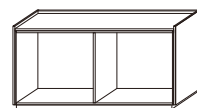
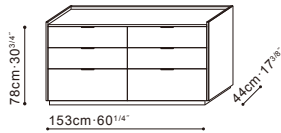

Internal Structure

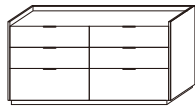

Cabinet (Without Top)

Dove + Graphite Oak + Driftwood

C04H0818.00.0000

Price (EURO) 1,645

VOL. 0.45m³

Natural Oak + Burlywood

C04H0818.00.0001

Price (EURO) 1,645

VOL. 0.45m³



Cabinet Top

Graphite Oak

B40H0818.00.0001

Price (EURO) 420

VOL. 0.05m³

Natural Oak

B40H0818.00.0000

Price (EURO) 350

VOL. 0.05m³

CABINET
MAX**Other Max products****Construction:****Frame**

- In grey oak veneer

Drawer

- Grey oak veneered drawer front
- Drawer structure in grey oak melamine
- Full extension invisible drawer runners with dampers (except C0416009)

Leg

- Black powder coated steel base with plastic glides

Hardware

- Black anodized aluminium handles
- Door hinges with dampers

N.B.: Back board of C0416006 comes with cord management hole cut

CABINET MAX

TV Stand
C0416004.

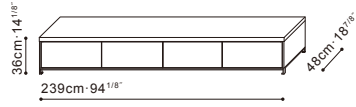

Grey Oak

C0416004.31.0000

1,925

VOL. 0.5m³

TV Stand
C0416006.

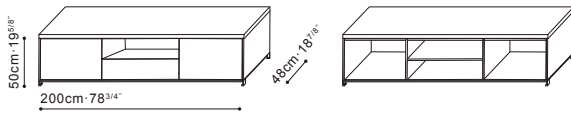

Grey Oak

C0416006.31.0000

1,470

VOL. 0.35m³

Sideboard
C0416008.

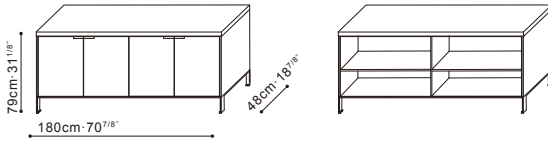

Grey Oak

C0416008.31.0000

1,470

VOL. 0.35m³

Drawer Cabinet
C0416011.



Grey Oak

C0416011.31.0000

840

VOL. 0.3m³

Drawer Cabinet
C0416022.

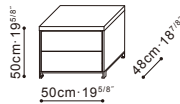

Grey Oak

C0416022.31.0000

805

VOL. 0.25m³

Drawer Cabinet
C0416012.

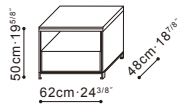

Grey Oak

C0416012.31.0000

735

VOL. 0.3m³

Drawer Cabinet
C0416023.

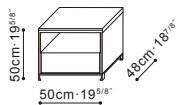

Grey Oak

C0416023.31.0000

700

VOL. 0.25m³

Drawer Cabinet
C0416015.

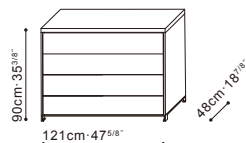

Grey Oak

C0416015.31.0000

1,855

VOL. 0.6m³

CABINET PIXEL

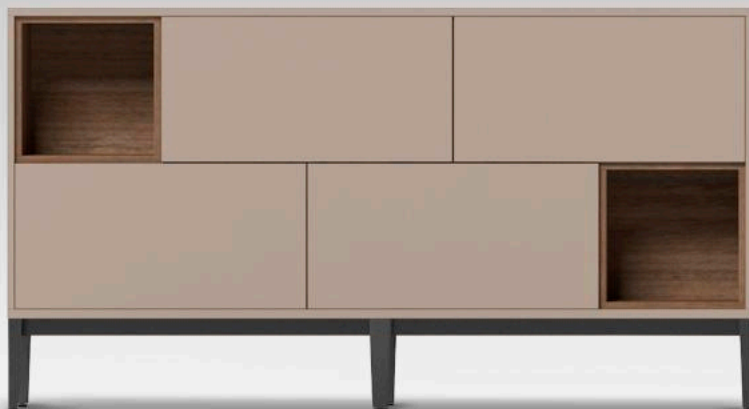

The Pixel series designed for contemporary homes, the clean shapes and precise geometries reorganizing open spaces and drawers with a special attention to volumes in a perfect fusion of aesthetic and practicability.

Construction:

Frame

- Available in matte Tuscan Tan lacquer and matte Dove lacquer, interior decorated in driftwood melamine
- Tempered transparent glass shelves for C0400202, C0400209, C0400210, and C0400217
- Downwards flap opening doors for C0400202 and C0400209

Leg

- Black metallic painted steel leg with plastic glides for C0400202, C0400209, and C0400217, height slightly adjustable for uneven floors
- Invisible wood base for C0400205, C0400218, and C0400219
- Above two base options both available for C0400203, C0400210, and C0400220

Hardware

- Door hinges with dampers
- Full extension push-pull drawer runners
- Damper hinge for flap doors with decelerated opening (For C0400202 and C0400209)

CABINET PIXEL

TV Stand C0400220. (High Feet)

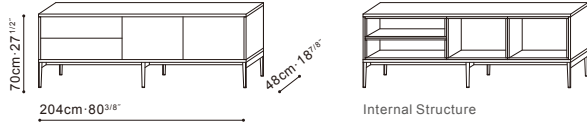

TV Stand C0400220. (Low Feet)

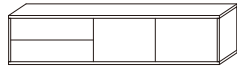
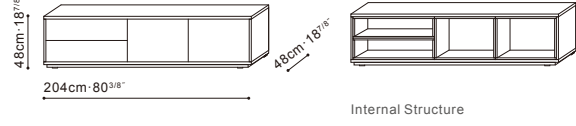

Cabinet (Without Base / Leg)

Tuscan Tan + Driftwood

C0400220.00.0001

1,400

Dove + Driftwood

C0400220.00.0000

VOL. 0.75m³

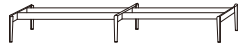

Cabinet Leg

Black Metallic Painted Steel

B4100210.3A.0001

350

VOL. 0.15m³

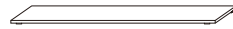

Cabinet Base

Driftwood

B4100210.20.0000

85

VOL. 0.1m³

TV Stand C0400203. (High Feet)

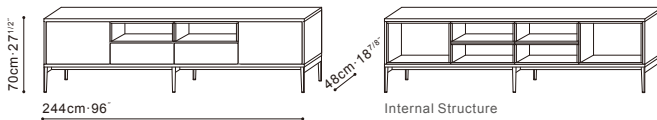

TV Stand C0400203. (Low Feet)

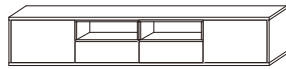
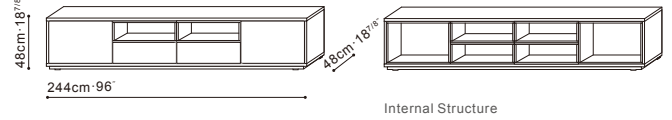

Cabinet (Without Base / Leg)

Tuscan Tan + Driftwood

C0400203.00.0001

1,555

Dove + Driftwood

C0400203.00.0000

VOL. 0.85m³



Cabinet Leg

Black Metallic Painted Steel

B4100203.3A.0001

420

VOL. 0.15m³



Cabinet Base

Driftwood

B4100203.20.0000

100

VOL. 0.1m³

PIXEL

Sideboard
C0400209.

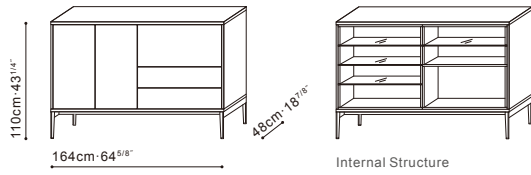

Tuscan Tan + Driftwood
C0400209.3A.0001

2,135

Dove + Driftwood
C0400209.3A.0000

VOL. 1.2m³

Sideboard
C0400210. (High Feet)

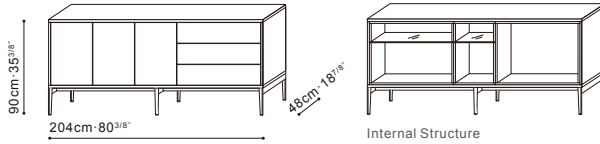

Sideboard
C0400210. (Low Feet)

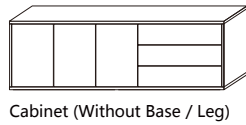
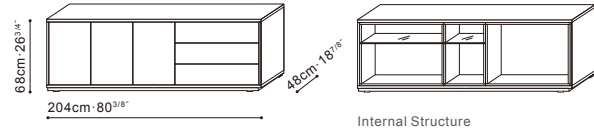

Cabinet (Without Base / Leg)

Tuscan Tan + Driftwood
C0400210.00.0001

1,820

Dove + Driftwood
C0400210.00.0000

VOL. 1.1m³

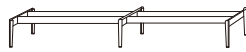

Cabinet Leg

Black Metallic Painted Steel
B4100210.3A.0001

350

VOL. 0.15m³

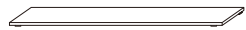

Cabinet Base

Driftwood
B4100210.20.0000

85

VOL. 0.1m³

Sideboard
C0400202.

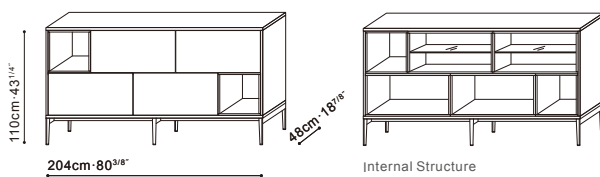

Dove + Driftwood
C0400202.3A.0000

2,520

VOL. 1.5m³

Sideboard
C0400217.

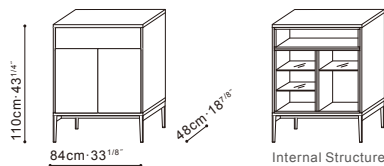

Tuscan Tan + Driftwood
C0400217.3A.0001

1,365

Dove + Driftwood
C0400217.3A.0000

VOL. 0.8m³

Drawer Cabinet
C0400218.

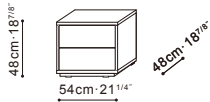

Tuscan Tan + Driftwood
C0400218.00.0001

630

Dove + Driftwood
C0400218.00.0000

VOL. 0.25m³

Drawer Cabinet
C0400219.

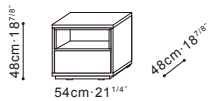

Tuscan Tan + Driftwood
C0400219.00.0001

560

Dove + Driftwood
C0400219.00.0000

VOL. 0.25m³

Drawer Cabinet
C0400205.

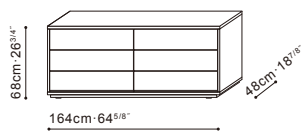

Tuscan Tan + Driftwood

C0400205.00.0001

1,785

Dove + Driftwood

C0400205.00.0000

VOL. 0.9m³

CABINET SEASON



Now you can decorate your room more lavishly with this premium modern wardrobe collection. SEASON is spacious, trendy in designs, and organized to fit all your clothes, bags, belts, shoes, blankets and more, all in one single place.

Construction:**Frame**

- Available in matte Tuscan Tan lacquer with driftwood melamine internal decoration

Drawer

- Push-pull drawer with invisible drawer runners
- Available in driftwood melamine

Leg

- Adjustable black plastic (ABS) hidden legs

Hardware

- Damper hinges with integrated soft-close mechanism
- Built-in handles in matte black metallic paint
- Aluminium hangers in grey metallic paint

N.B.: comes with LED light

CABINET SEASON

Wardrobe
CF400306.

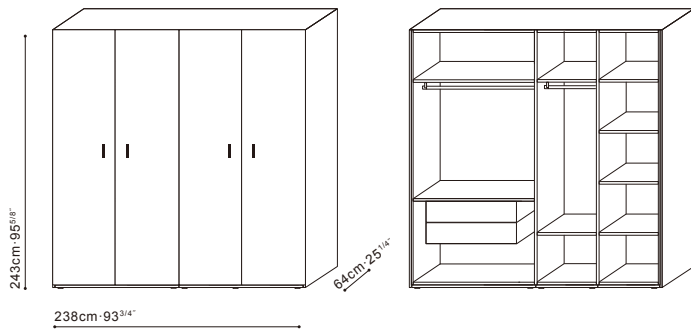

Tuscan Tan + Driftwood
CF400306.00.0000

5,180

VOL. 1.8m³

Wardrobe
CF400310.

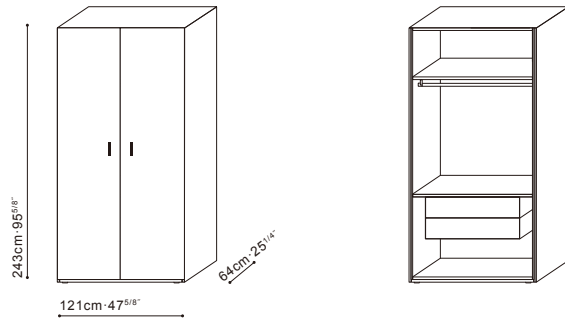

Tuscan Tan + Driftwood
CF400310.00.0000

2,975

VOL. 1.1m³

COAT RACK

LESSO 260

MIRROR

BELL 262

CHARM 264

COAT RACK LESSO



- Solid ash wood frame
- Available in grey oak finish

COAT RACK LESSO

Coat Rack
C0715190.

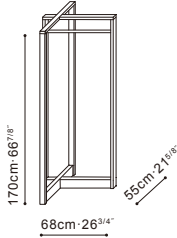

Grey Oak
C0715190.07.0000

375

VOL. 0.25m³

MIRROR BELL



- Mirror surface with PB backing
- Black powder coated steel frame

MIRROR BELL

Mirror
C0716191.

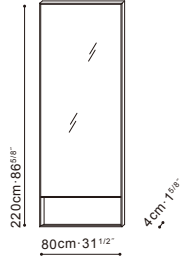

C0716191.31.0000

590

VOL. 0.3m³



MIRROR CHARM

C07E0401 Rectangular Mirror

- Mirror surface with PB backing
- Black metallic paint steel frame
- Solid ash wood tray in grey oak finish
- Back board comes with tip-restraint unit, available wall-mounted

C07E0402 Round Mirror

- Mirror surface with PB backing
- Solid ash wood frame in grey oak finish
- Wall-mounted only

MIRROR CHARM

Mirror
C07E0401.

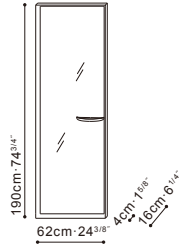

Grey Oak Color Tray
C07E0401.3A.0000

815

VOL. 0.25m³

Mirror
C07E0402.

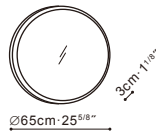

Grey Oak Color
C07E0402.07.0000

300

VOL. 0.1m³

Leather Products Stitched Seams Details

Upon discretion of CAMERICH, all leather products can have one or more stitched seams depending on products size.



AMOR (New)

(Dotted line refers to stitched seams)

C01F0102.

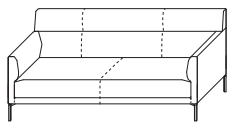

C01F0103.

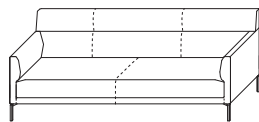

C01F0104.

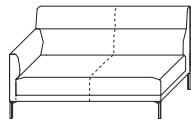

C01F0105.

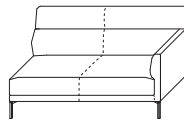

C01F0106.

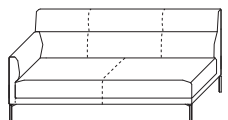

C01F0107.

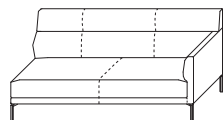

C01F0112.

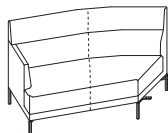

C01F0113.

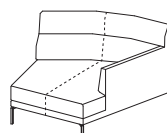

C01F0114.



C01F0115.

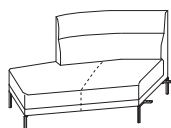

C08F0101.



AMOR

C01B0101.

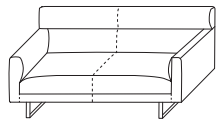

C01B0102.

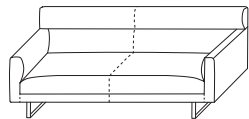

C01B0103.

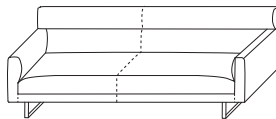

C01B0104.

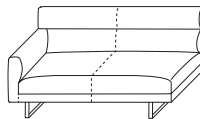

C01B0105.

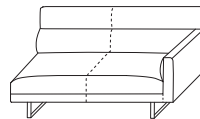

C01B0106.

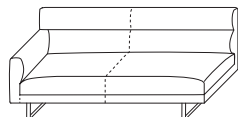

C01B0107.

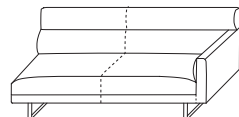

C01B0108.

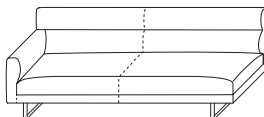

C01B0109.

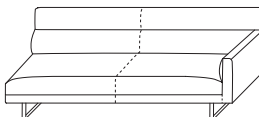

C01B0120.

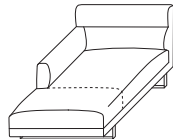

C01B0121.

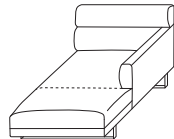

C01B0114.

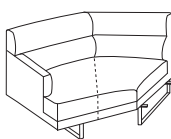

C01B0115.

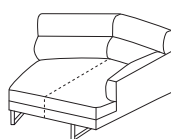

C01B0116.

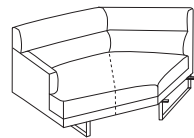

C01B0117.

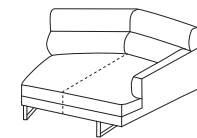

C08B0101.



C08TYK01.



BLOOM

(Dotted line refers to stitched seams)

No stitched seam on the front of defaulted back cushions

C01G0101.

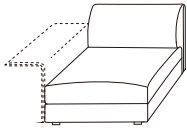

C01G0102.

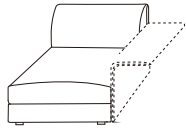

C01G0103.

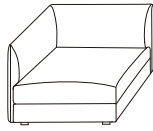

C01G0104.

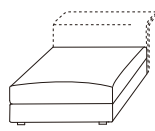

C01G0105.

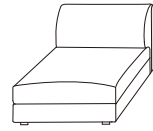

C01G0106.

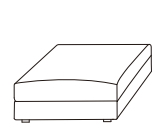

C01G0107.

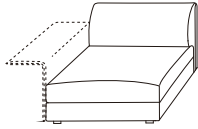

C01G0108

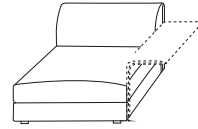

C01G0109.

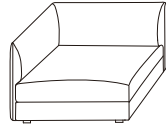

C01G0110.

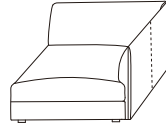

C01G0111.

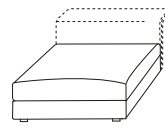

C01G0112.



C01G0113.

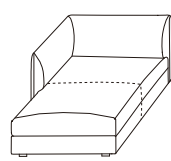

C01G0114.

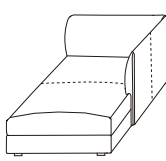

C01G0117.

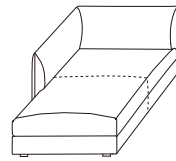

C01G0118.

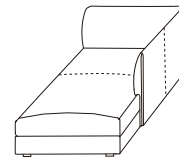

C01G0121.

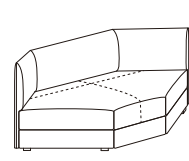

B12G0122.



B12G0123.



C08G0104.



CASA

C0102025.

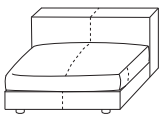

C0102026.

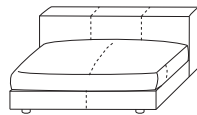

C0102027.

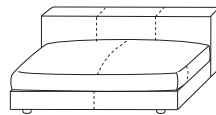

C0102010.

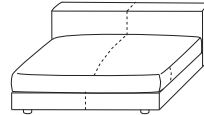

C0102011.

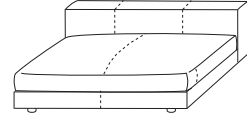

C0102017.

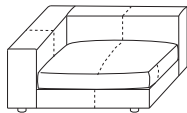

C0102018.

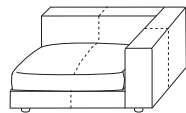

C0102019.

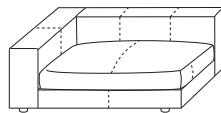

C0102020.

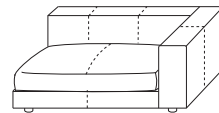

C0102003.

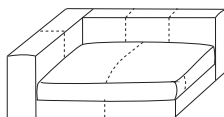

C0102004.

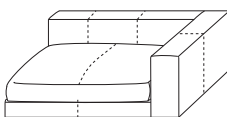

C0102005.

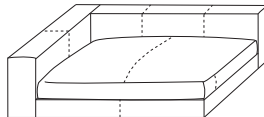

C0102006.

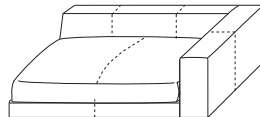

C0102013.

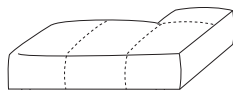

C0102014.

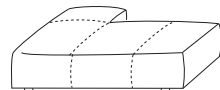

C0102015.

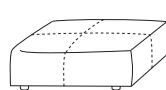

C0102016.

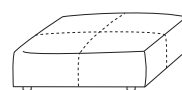

C0802004.



C0802003.



C0802002.



C0802001.



CLOUDS

(Dotted line refers to stitched seams)

C0102201.

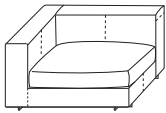

C0102202.

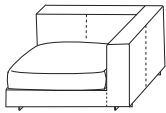

C0102203.

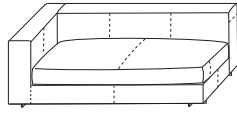

C0102204.

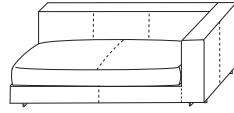

C0102206.

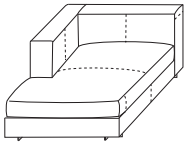

C0102205.

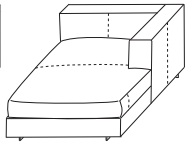

C0102207.

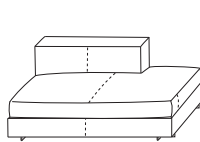

C0102208.

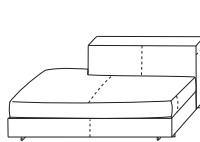

C0102209.

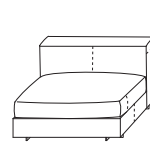

C0102210.

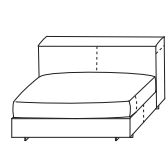

C0102211.

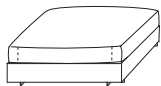

C0802201.



C0802202.



C0802203.



C0802204.



CRESCENT

(Dotted line refers to stitched seams)

C0102118.

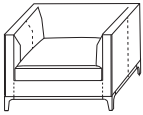

C0102119.

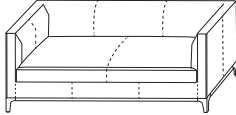

C0102102.

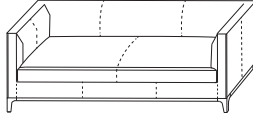

C0102103.

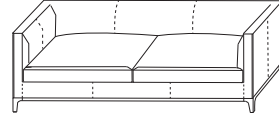

C0102104.

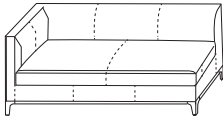

C0102105.

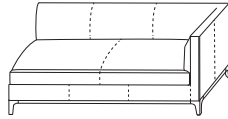

C0102110.

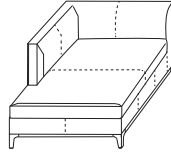

C0102111.

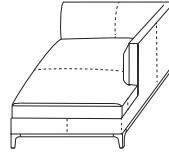

C0102117.

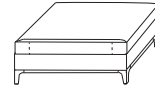

C0802101.

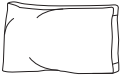

C0802102.



C0802103.



C0802104.



C0802105.



EAST-WEST

No stitched seam on the front of defaulted back cushions

C01H0101.



C01H0102.

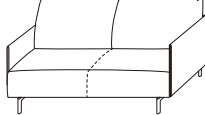

C01H0103.

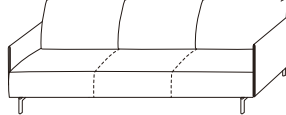

C01H0104.

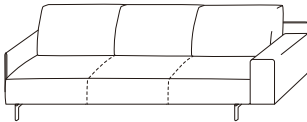

C01H0105.

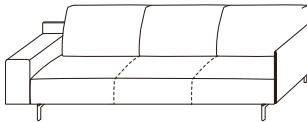

C01H0106.

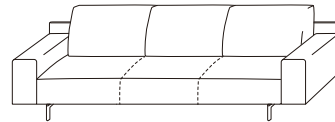

C01H0108.

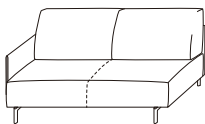

C01H0109.

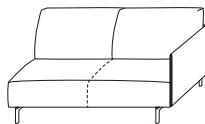

C01H0110.

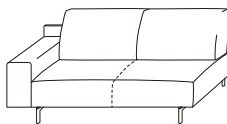

C01H0111.

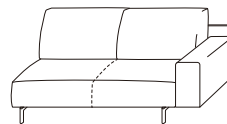

C01H0116.

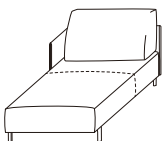

C01H0117.

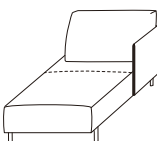

C01H0118.

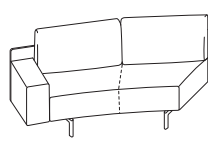

C01H0119.

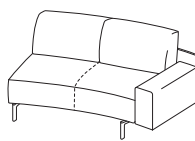

C08H0103.



C08H0104.



C08H0105.



EASYTIME

(Dotted line refers to stitched seams)

No stitched seam on the front of defaulted back cushions

C01F0901.

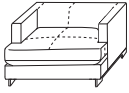

C01F0902.

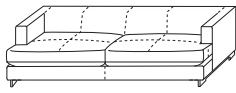

C01F0903.

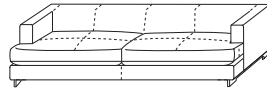

C01F0904.

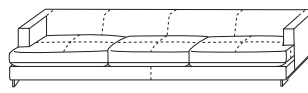

C01F0905.

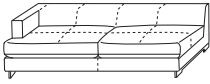

C01F0906.

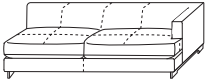

C01F0907.

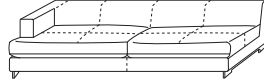

C01F0908.

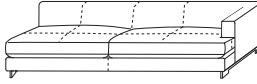

C01F0909.

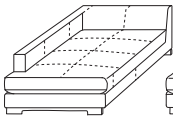

C01F0910.

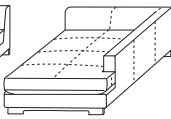

C01F0911.

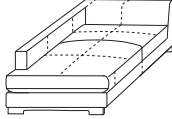

C01F0912.

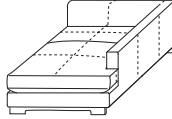

C01F0913.

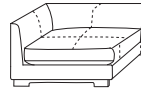

C01F0914.



C01F0915.

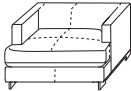

C01F0916.

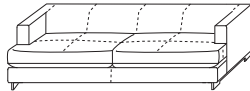

C01F0917.

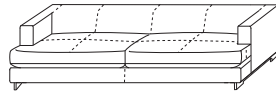

C01F0918.

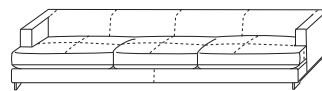

C01F0919.

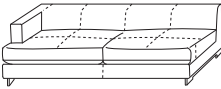

C01F0920.

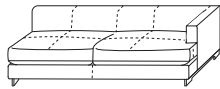

C01F0921.

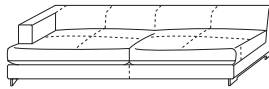

C01F0922.

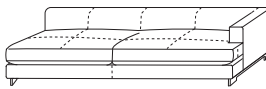

C01F0923.

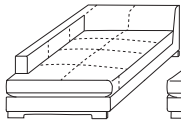

C01F0924.

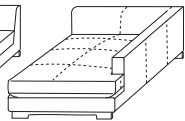

C01F0925.

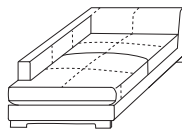

C01F0926.

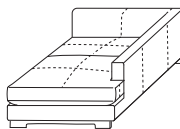

C01F0927.



C01F0928.

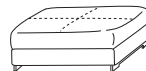

C08F0904.



C08TYK01.



ELAN (New)

(Dotted line refers to stitched seams)

One seam runs vertically in the middle of defaulted back cushions

C01F0201.

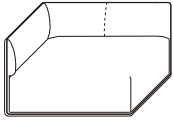

C01F0202.

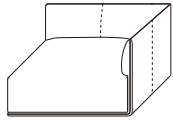

C01F0203.

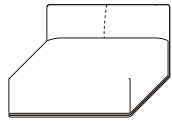

C01F0217.

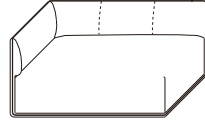

C01F0218.

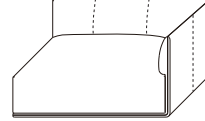

C01F0204.

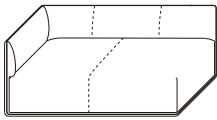

C01F0205.

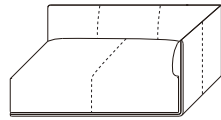

C01F0206.

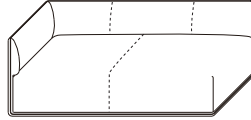

C01F0207.

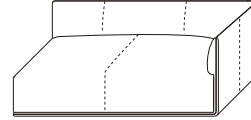

C01F0208.

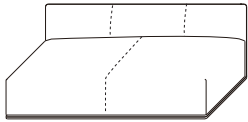

C01F0209.

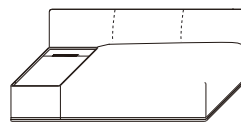
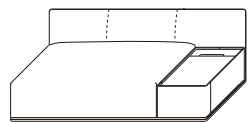

C01F0210.

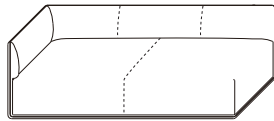

C01F0211.

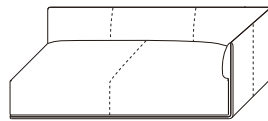

C01F0212.

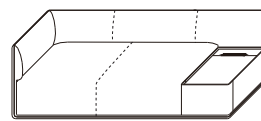

C01F0213.

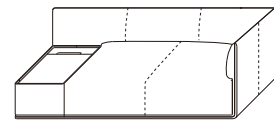

C01F0214.

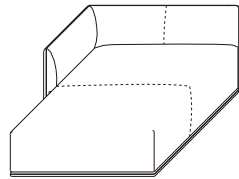

C01F0215.

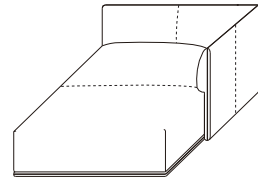

C08F0204.



C08F0204.



C08TYK01.



ELAN

(Dotted line refers to stitched seams)

One seam runs vertically in the middle of defaulted back cushions

C01B0201.

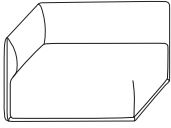

C01B0202.

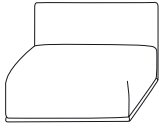

C01B0203.

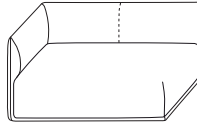

C01B0204.

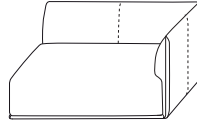

C01B0205.

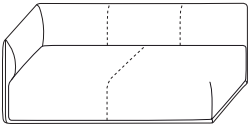

C01B0206.

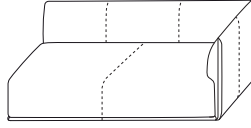

C01B0207.

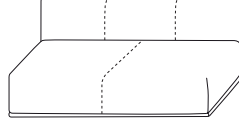

C01B0208.+C06B0315.

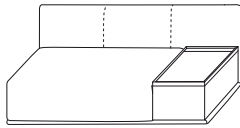
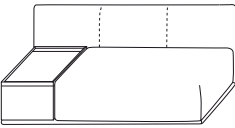

C01B0213.

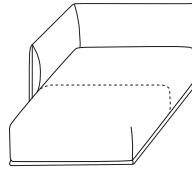

C01B0214.

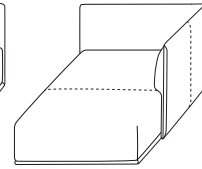

C01B0211.+C06B0316.

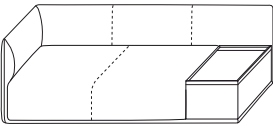

C01B0212.+C06B0316.

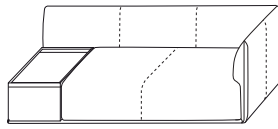

C01B0209.

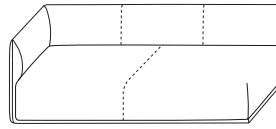

C01B0210.

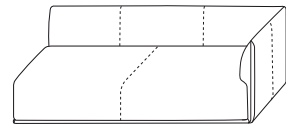

C08B0204.



C08B0204.



C08TYK01.



EPIC

C01H0201.

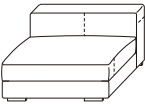

C01H0202.

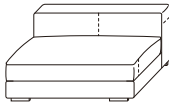

C01H0203.

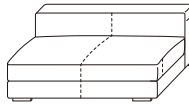

C01H0204.

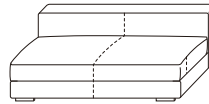

C01H0205.

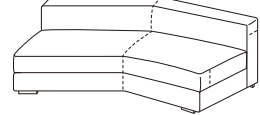

C01H0206.

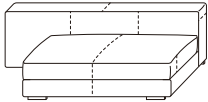

C01H0207.

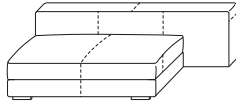

C01H0208.

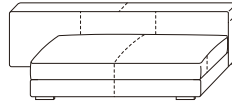

C01H0209.

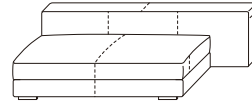

C01H0210.



B12H0211.



B12H0212.



B12H0213.



B12H0214.



B12H0215.

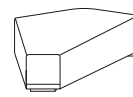

C08H0201.



C08H0202.



C08H0203.



C08H0204.



C08H0205.



C08H0206.

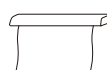

C08H0207.



C08H0208.



MODA

(Dotted line refers to stitched seams)

C01G0201.

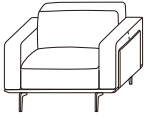

C01G0203.



C01G0204.



C01G0205.



C01G0206.

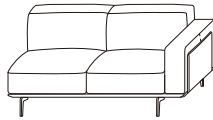

C01G0207.

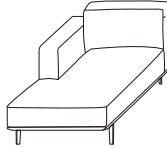

C01G0208.

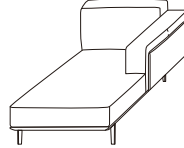

C01G0209.

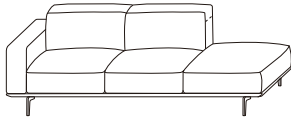

C01G0210.



NATURE

C01E0601.

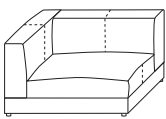

C01E0602.

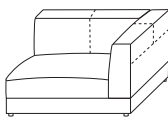

C01E0603.

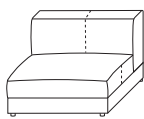

C01E0606.

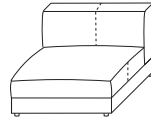

C01E0604.

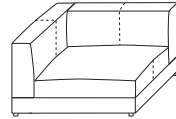

C01E0605.

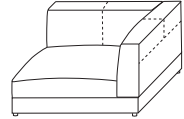

C01E0607.

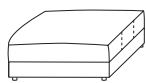

C01E0608.



C08E0601.



C08E0602.



C08TYK01.



RUBIX

C01C0131.



C01C0132.



C01C0133.

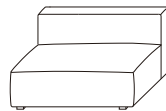

C01C0134.

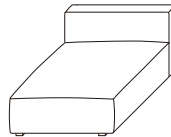

C01C0135.



C01C0136.



C01C0137.



C01C0138.



C01C0139.

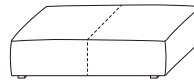

C01C0140.

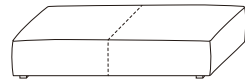

C01C0141.



C01C0142.



C01C0143.



C01C0144.

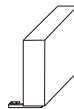

C08C0104.



C08C0105.



C81C0106.



C08C0107.



WAKE

(Dotted line refers to stitched seams)

One seam runs vertically in the middle of defaulted back cushions

C01D0201.

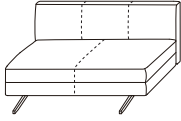

C01D0202.

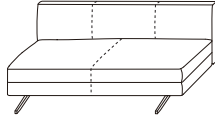

C01D0203.

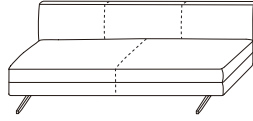

C01D0205.

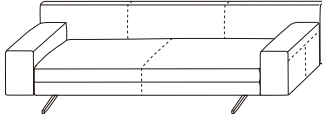

C01D0206.

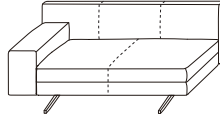

C01D0207.

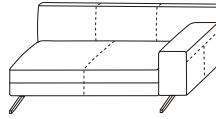

C01D0212.

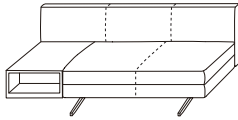

C01D0213.

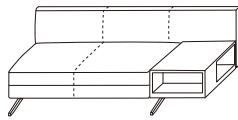

C01D0208.

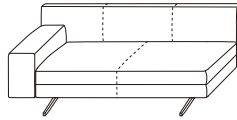

C01D0209.

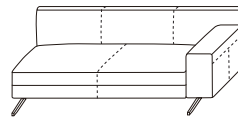

C01D0210.

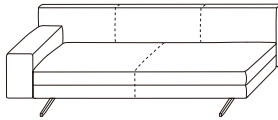

C01D0211.

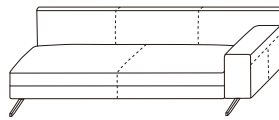

C01D0214.

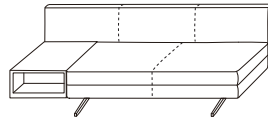

C01D0215.

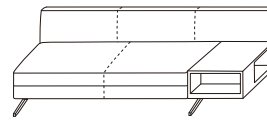

C01D0216.

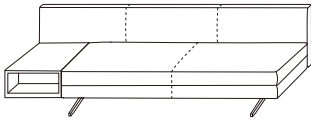

C01D0217.

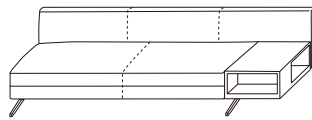

C01D0218.

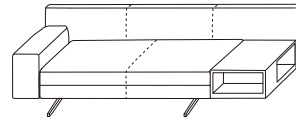

C01D0219.

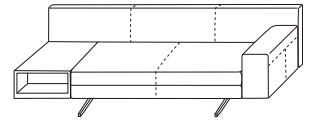

C01D0220.

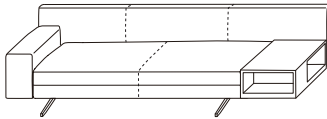

C01D0221.

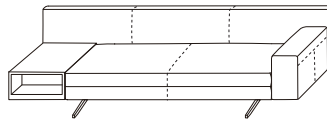

C01D0222.

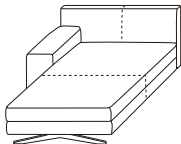

C01D0223.

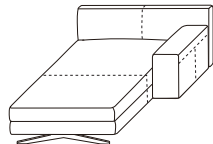

C01D0230.

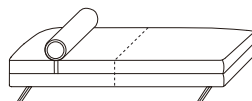

C08TYK01.



EASE

C02C0304.

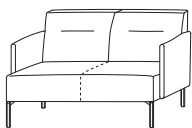

EMBRACE

C02D0602.

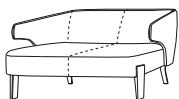

ECHO (Dotted line refers to stitched seams)

C02D0902.



VENUS

C02A1702.



AMOR

(Dotted line refers to stitched seams)

C03J0301.

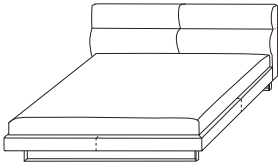

C03J0302.

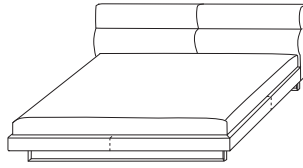

C03J0304.

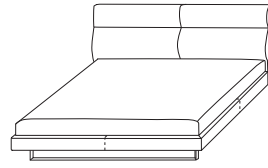

C03J0305.

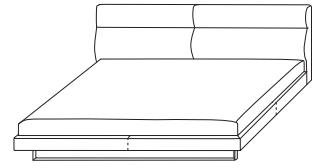

ALISON BED PLUS

C03J0201.

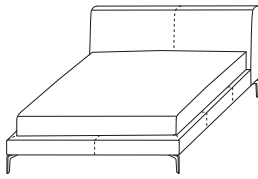

C03J0202.

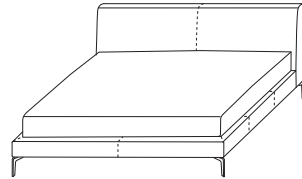

C03J0204.

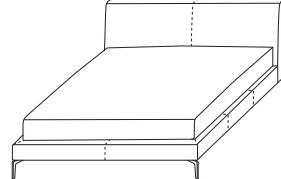

C03J0205.

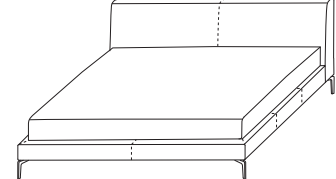

CRESCENT BED

C03J0401.

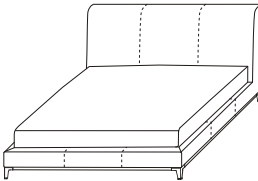

C03J0402.

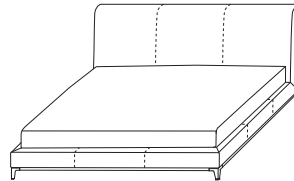

C03J0403.

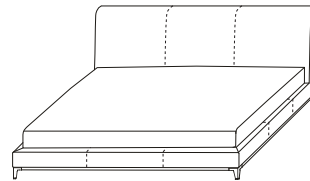

C03J0404.

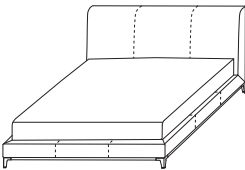

C03J0405.

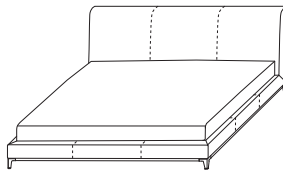

C03J0431.

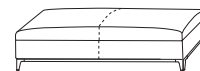

EDEN

C03G0501.

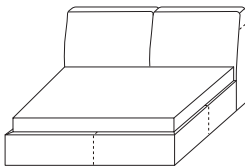

C03G0502.

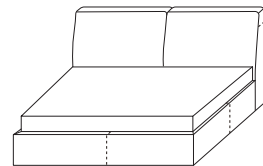

C03G0504.

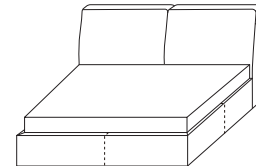

C03G0505.

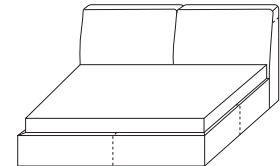

ELAN

(Dotted line refers to stitched seams)

C03D0501.

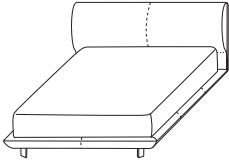

C03D0502.

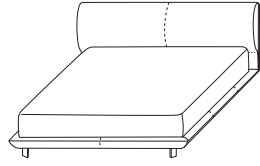

C03D0503.

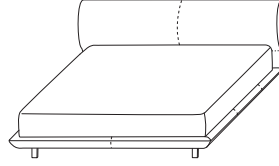

C03D0504.

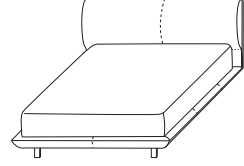

C03D0505.

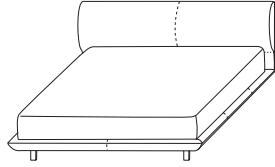

EMBRACE

C03E0101.

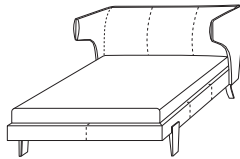

C03E0102.

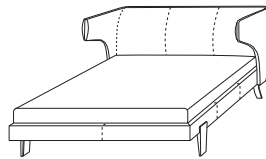

C03E0103.

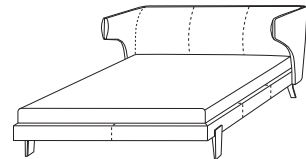

C03E0104.

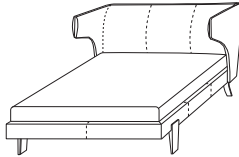

C03E0105.

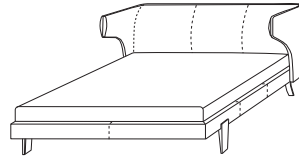

LUNA

C03F0601.

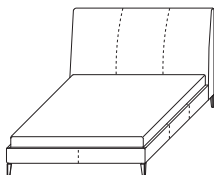

C03F0602.

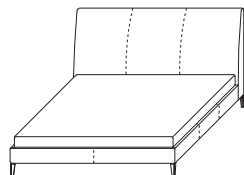

C03F0603.

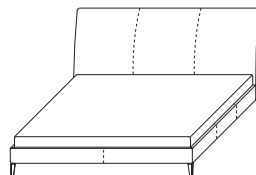

C03F0604.

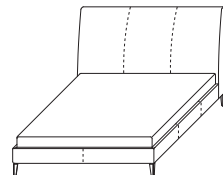

C03F0605.

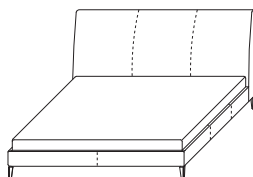

C03F0611.

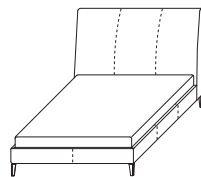

C03F0612.

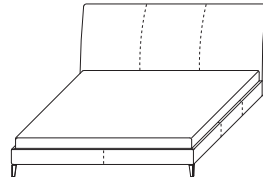

MELODY

(Dotted line refers to stitched seams)

C03H0701.

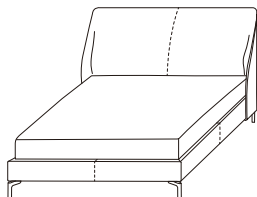

C03H0702.

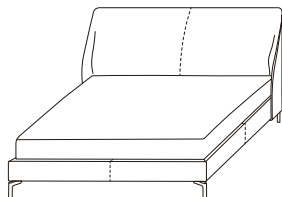

C03H0704.

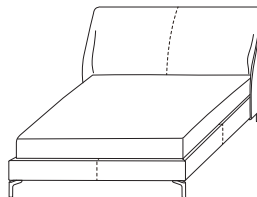

C03H0705.

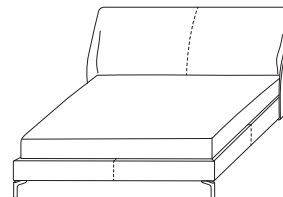

C08H0701.



C08H0702.



C08H0703.



C08H0704.



NATURE

C03E0701.

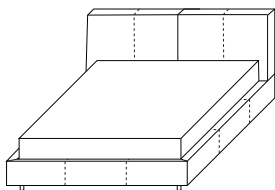

C03E0702.

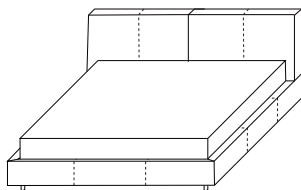

C03E0703.

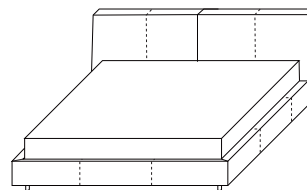

C03E0704.

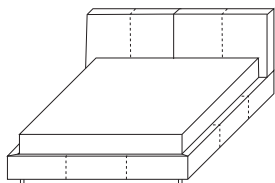

C03E0705.

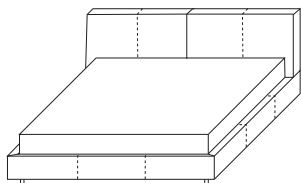

C03E0712.

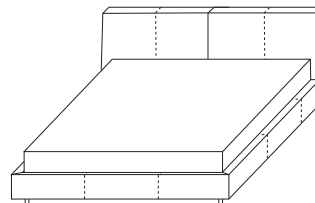

STRATUS

(Dotted line refers to stitched seams)

C03J0102.

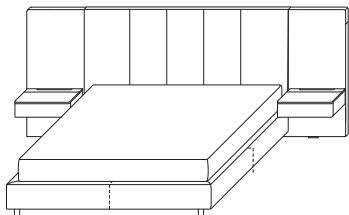

C03J0103.

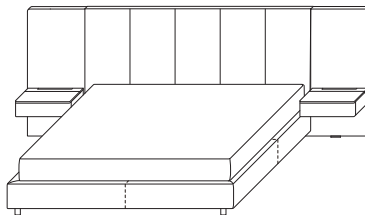

C03J0112.

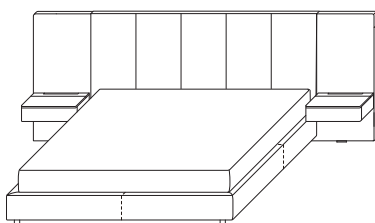

C03J0105.

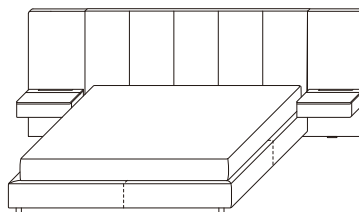

C03J0121.

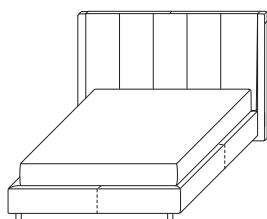

C03J0122.

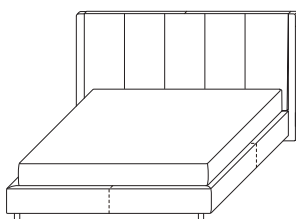

C03J0123.

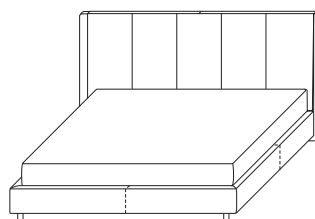

C03J0132.

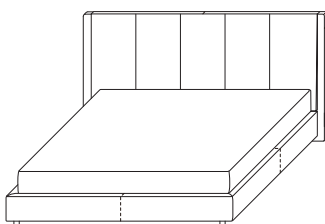

C03J0124.

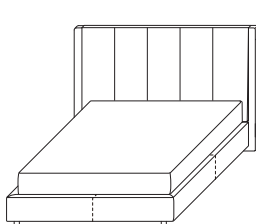

C03J0125.

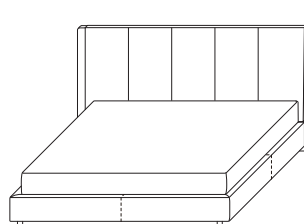

Products Care Instructions

Fabric Upholstered Products

Vacuum-clean fabric upholstered products every two weeks to minimize the presence of dust. Use a soft, gentle brush head to avoid surface scratches. Use only fabric cleansers to remove stains, but test the cleanser on back or underside areas of the product first. If more thorough washing is necessary, a professional dry cleaner is recommended.

Leather Upholstered Products

Minimize the presence of dust by gently wiping the surface with a soft cloth. To remove stains, use a clean, soft damp cloth or leather cleanser.

Cushion Inserts

Maintain shape and elasticity of cushion inserts by patting regularly. During rainy or moist seasons, or in humid environments, use a dehumidifier in the space.

Wood Furniture

Wipe furniture with a soft damp cloth in the direction of grain. In the event of a stain, use a professional cleaning agent.

Rattan Woven Products

Rattan strip crevices are prone to mold during moist seasons. To remove mold, apply light salt brine onto a soft cloth and clean strips on a regular basis.

Marble/Ceramic Products

Wipe with a soft damp cloth for daily maintenance. To remove stains, use natural cleansers and gently scrub the stains.

Metal Products

Wipe with a soft cloth to remove dust and stains. Keep products away from oily, acidic and alkaline liquids. Condensation on metal surfaces should be removed with a dry cloth to prevent rust. In the event of rust, consult a professional for assistance.

Camerich Limited Warranty Terms

CAMERICH is subject to all limitations and exclusions described in these Limited Warranties. The following CAMERICH products and parts are warrantied against material and manufacturing defects for the duration upon delivery set forth next to that product or part in the table below:

Upholstered Furniture Products or Parts	Limited Warranty Coverage	Limited Warranty Duration
<p>Wood or Metal Frame Including Springs and Webbed Seating System The metal spring systems are generally sinuous wire seat springs. The Webbed Seating System is the cross-woven elastic webbing used to support the seating area.</p>	Frame structure damage	10 Years
Cushion Cores Including Seat Cushions, Back Cushions, Throw Cushions and Polyurethane Foam Used on Wood or Metal Frames	Severe deformation or collapse	2 Years
Leather and Fabric Covers	Severe fabric pilling and fading; Leather cracking	2 Years
<p>Upholstered Products Metal Components and Hardware Upholstered products metal components, including metal legs, sofa connectors and other metal components not specifically included in the above Limited Warranties.</p>	Not operating smoothly; Metal rusting	2 Years

Panel-type Products or Parts	Limited Warranty Coverage	Limited Warranty Duration
Wood Frame The wood frame, including wood tops, legs and boards used in drawers and cabinets, and other wood components not specifically included in the above Limited Warranties.	Frame structure damage	10 Years
Panel-type Products Metal Components and Hardware Panel-type products metal components, including metal legs, handles, motion mechanisms and other metal components not specifically included in the above Limited Warranties.	Not operating smoothly; Metal rusting	2 Years
Marble Tops	Broken; Resin coating yellowing	2 Years
Ceramic Tops	Broken	2 Years
Mirror Components	Mirror distortion	2 Years
Glass	Broken	2 Years

P.S. Any replaced parts will be covered by the Limited Warranties for the renewal of the original warranty period.

LIMITATIONS AND EXCEPTIONS

The following limitations and exceptions apply to the Limited Warranties:

- All warranties, whether express or implied, cover only normal household usage. They do not apply to defects or damage resulting from negligence, abuse or misuse – including but not limited to inadequate or improper maintenance, exposure to water, chemicals, accidents or any use for which the product was not designed, nor do they cover ordinary wear and tear.
- These Limited Warranties do not apply to any products that have been altered by any person, dealer or company without the express written authorization of CAMERICH.
- These Limited Warranties do not apply to products that are designated as having “defects” or “not suitable for return or exchange” before purchase.

GREGOIR RÊVE



CAMERICH

www.gregoir.com/reve/camerich/
reve@gregoir.com
+32 2 474 04 76